

16/17
Aug/Sept
1984

elektor **INDIA**

Rs. 15-00

electronics

Suresh Singh



**circuits
special '84**

more than 100
practical projects

contents

message from your editor	8-15
readership survey	8-57
market	9-02
appointments	9-10
switchboard	9-11
advertisers index	9-14
missing link	9-14

audio, video, and sound generation

amplification selector	8-88
stereo doorbell	8-51
audio preamp buffer	8-71
digital band-pass filter	8-42
guitar preamplifier	8-28
infra-red headphones: receiver	8-89
infra-red headphones: transmitter	8-84
scratch and rumble filter	8-96
screen noise killer	8-74
70/90 watt amplifier	8-52
small high-power amplifier	8-34
stereo balance indicator	8-77
stereo noise suppressor	8-72
switch-on delay	8-90
sync separator	8-85
touch-pad potentiometer	8-28
voltage-controlled audio switch	8-40

computers and microprocessors

cpu clock generator	8-77
elektterminal bell	8-76
EPROM eraser	8-93
fast analog to digital converter	8-83
floppy expander	8-43
joystick interface	8-56
jump on reset	8-82
level indicator	8-32
lightpen	8-21
μ P infra-red interface	8-33
mini signal cleaner	8-86
multi-channel analog to digital converter	8-64
parallel/serial converter	8-16
power switches for μ Ps	8-36
6502 bootstrap	8-97
RS 232 analyser	8-61
three-state indicator	8-86
2716 versus 2708	8-32
twin RS 232	8-34
$2 \times 2716 = 2732$	8-84

domestic

alarm timer	8-85
automatic clockroom light	8-31
automatic reserve warning light	8-26
blown-fuse indicator	8-94
central-heating monitor	8-24
coffee temperature indicator	8-97
electronic mousetrap	8-68
energy-saving porch light	8-67
flashing telephone light	8-92
fridge alarm	8-19
kilowatt dimmer	8-30
musical door-bell	8-80
rain indicator	8-35
single-button code lock	8-48
sonic deterrent	8-69
super-simple bell extension	8-96

temperature reading on a multimeter	8-26
twin door-bell	8-63
2N3055 sun switch	8-45

generators and oscillators

auto duty cycle	8-90
baud rate generator	8-20
pulse generator	8-37
sawtooth generator	8-99
Wien bridge oscillator	8-78

H.F.

F.M. pocket radio	8-53
time-signal receiver	8-23
VHF/AM air-band converter	8-54
VHF converter	8-73

hobby and car

alarm clock for cars	8-29
automatic reserve warning light	8-26
fatigue tester	8-69
guitar preamplifier	8-28
'lights on' warning	8-78
pace counter	8-17
remote shutter release	8-42
revolution counter	8-44
self-switching battery charger	8-45
speed regulator for disco lights	8-16
stroboscope	8-70

measuring and test equipment

amplification selector	8-88
audible ohmmeter	8-95
combining 4017 counters	8-65
digILED	8-66
frequency meter	8-38
hi-lo pulse rate discriminator	8-82
LC meter	8-30
LED current sensor	8-75
level indicator	8-32
parser	8-94
three-state TTL logic probe	8-88
transistor polarity tester	9-00
VHF dipper	8-36
'window' LEDs	8-95

power supplies

dissipation limiter	8-49
high-power opamp supply	8-64
linear opto-coupler	8-91
low-power switching regulator	8-79
microcomputer power supply	8-46
microcomputer power supply protection	8-87
NiCad charger	8-40
overvoltage protection	9-01
power supply considerations	8-74
power supply for computers	8-55
power supply monitor	8-27
transformerless mains power supply	8-70

miscellaneous

bird imitator	8-41
blown-fuse indicator	8-94
economical motor-driving circuit	8-98
electronic key-set	8-49
event counter	8-81
funny bird	8-62
one-armed bandit	8-51
photoelectronic relay	8-50
switch indicator	9-00
switching delay	8-18
valve simulator	8-20
versatile timer	8-22
voltage-controlled audio switch	8-40

A New page has been added to LCR History !



VLCR7

Measurement of **INDUCTANCE, CAPACITANCE, RESISTANCE** are greatly simplified by VLCR 7. No balancing, no adjustments.

Connect the component to the terminals. VLCR 7 gives you directly the digital reading of value and its loss factor simultaneously.

FOUR TERMINAL measurement eliminates inherent errors due to lead resistance. **GUARD TERMINAL** provided eliminates errors due to lead capacitance.

VLCR 7 is the only instrument in India covering the widest ranges of 0.1 pf/uH/m ohm (ie. 0.0001 ohm) to 20,000 uf/200H/20 M ohm.

*Do not be mad of B.W. if you do not need.
But a Scope with Component tester is all the while required.*

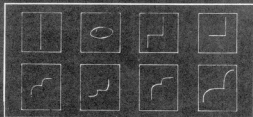
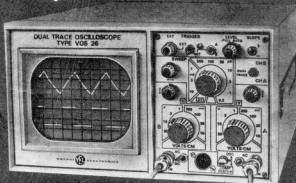

DIGITAL FREQUENCY COUNTER VDC 18



Smallest size ever made in INDIA

Battery cum mains operated
wide frequency range 30MHz
(our model VDC 19 is 500MHz)
Basic sensitivity of 10mv
Bright LED display 7 digit

for details write to:
VASAVI ELECTRONICS
162, Vasavi Nagar,
SECUNDERABAD-500 003.
Ph. 70995 Grams: VELSCOPE

VEL

Range of our Products:

Oscilloscopes • Curve Tracers
Oscillators • Function Generators
Micro Processor Trainers

Digital

LCR Meters • Capacitance Meters
Multimeters • Milli OHM Meters
Micro Voltmeters • Frequency Counters

Robot in BEL plant

Bharat Electronics Limited, Bangalore, does not stop with the production of black and white TV picture tubes; it can now offer the state-of-the-art technology itself for picture tube production plant of any capacity, on a turn-key basis.

This ability of the BEL was evident when its second picture tube plant was inaugurated by the Union deputy minister for electronics, Dr. M. S. Sanjeevi Rao, recently.

Except for two test equipment, the conception, design and erection of the entire semi-automated plant was indigenous and an additional feature of the plant was the introduction of a robot in the production line, according to Mr. N. L. Krishnan chairman and MD of the BEL. Controlled by a microprocessor, the robot collects screen coated TV bulbs from two continuously rotating, screen coating equipment and unloads them on an indexing type, twelve-head, drying machine. It controls release of coated bulbs, rotates the lower arms to pre-determined positions, centres the neck of the TV bulb, lifts it, rotates 180 degrees and places the bulb on the drying equipment.

With the commissioning of the new plant, BEL's total installed capacity will be 300,000 TV tubes per annum. The semi-automated plant's capacity is 100,000 tubes per annum.

The pneumatically-operated robot, while maintaining quality and imp-

roving productivity, eliminates operator fatigue and health hazards, points out Mr. K. R. Savor, general manager (components) of the BEL.

The BEL has also announced a reduction in the prices of TV picture tubes, thanks to the improved productivity. The wholesale, ex-factory price for 20" black and white picture tube has been reduced from Rs. 390 to Rs. 370. The wholesale price at various outstation depots will be reduced from Rs. 420 to Rs. 385. The maximum benefit, however, goes to the buyer from the BEL sales depots where the retail price has been slashed to Rs. 430 from Rs. 520. Similarly, prices of other sizes of tubes have also been reduced.

ELCOT Ventures

Electronics Corporation of Tamil Nadu Ltd. (ELCOT), which has set up an aluminium electrolytic capacitor plant and digital electronic watch unit with Japanese technology, is implementing a two-way radio communication equipment project, in collaboration with Marconi, U.K.

ELCOT intends to have joint venture projects with any entrepreneur. A joint venture for metal and carbon film resistors has already been taken up and two more ventures, for mini-computers and terminals and video recorders/players are under consideration.

ELCOT also holds letters of intent for telephone instruments, inclu-

ding push button and memory bank type instruments, medium and high power X-ray system with accessories, low power X-ray system with accessories, mini-computers, terminals and printed circuit boards. The entrepreneurs can also contact ELCOT with their own schemes.

Japan looks to India

One of the largest firms in Japan, Software Consultant Corporation, has given an assignment to the Bangalore-based computer manufacturers, Processor Systems (India) Pvt. Ltd., to design and develop a system for computer-based education. PSI claims this is the first time that an Indian firm has bagged an assignment of this nature from Japan.

Apart from two host computers and 80 terminals, the products to be developed by the PSI include, a full set of hardware documentation, basic software for the system and a full set of related software documentation, both in English and Japanese versions. The project is expected to be implemented in five phases from April, 1984 to June, 1985 and the PSI earns a fee of about US dollars 300,000 for the project.

Software exports

Computer software exports from India to USA, USSR, West Europe, South East Asia, Australia, New Zealand and the Gulf countries may touch Rs. 100 crores per annum in the next three years, forecasts the Union commerce ministry. This optimism is based on the fact that software exports registered a 48 percent increase in 1983-84. It rose to Rs. 20 crores from Rs. 13.5 crores.

Among the steps taken by the ministry for augmentation of software exports are: liberalised import of computer software, hardware and peripherals, including central processing unit, memory augmentation, crossing assemblies, VD assemblies, D-compilers, compiler programme generator, flow chart generators, debugging and diagnostic tools, performance evaluation and monitoring tools, testing equipment, consumables and supplies related to export capability.

Turning to electronics in export from electronics export, the government will set up a computerised engineering data system to provide quick and up-to-date information on India's engineering capabilities to importers abroad and potential foreign markets.

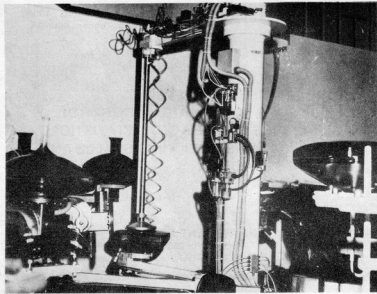

ROBOT IN BEL PLANT

100+ Circuits Special

Circuits Special

Arguably, this is one of Elektor's most popular traditions: more than one hundred circuits packed into one issue. Some people say that it is the only issue of Elektor they buy, while others claim that it is the only one they don't buy! Be that as it may . . .

Some people have expressed their doubt about our claim that all circuits are lab-tested: 'Why, sometimes the components don't even exist!' Hmm . . . This year we have included a photo of the prototype in each article. Convinced? And as to the components, well . . . we can't guarantee that they are all readily available now. They exist, they are in production — but they may not be in your local shop yet.

For that matter, electronic components are a problem world-wide at present. Not just exotic types: even standard TTL and CMOS. Some computer manufacturers are in extreme difficulties because they can't get certain parts. This immediately affects the retail trade. Some items are impossible to obtain; others are available only in limited quantities and at incredibly inflated prices. (We heard of one case recently where a retailer was offered a batch of 1000 ICs at a price that was nearly three times his own advertised sales price!)

However, let's look at the bright side. If electronic components are in such demand, electronics is still booming. So we can expect lots more interesting developments in the future: new technology, new components — and cheaper, too, once the manufacturers catch up with the demand!

Meanwhile, this issue reflects the current state-of-the-art. Some projects are just good, traditional designs; some use components that have only recently become available; finally, there are a few that may only become true 'home-construction' projects a few months from now. All-in-all, it should keep a lot of people busy for some time to come!

Finally, a word of warning to new readers. Another of our traditions is to include one joker in the pack. In other words, there is one project that is rather less 'practical' than the others. If you try to build that one, we wish you luck!

Your editor

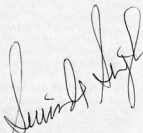

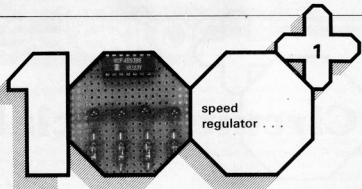

speed regulator . . .

. . . for disco lights

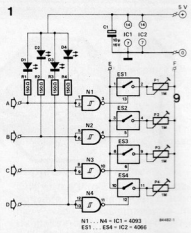

N1 . . . N4 - IC1 - 4093
E51 . . . E54 - IC2 - 4066

It is interesting to be able to vary the run-off speed of the disco lights featured in our March 1984 issue. Not many changes to the circuit then published are needed, and even those are small. The additional circuit illustrated is connected to that of the disco lights via A . . . F shown in figures 1 and 2 (the latter is the component layout of the printed circuit for the disco lights). Preset P1 in the disco lights circuit should be set to maximum resistance because it is connected in parallel with any of the four presets in the present circuit. When the disco lights are being programmed, the four new channels should, of course, be included. When a logic 1 is programmed, the buffer outputs (N42 . . . N45) are low and they must therefore be inverted in N1 . . . N4 to be able to drive the CMOS switches. It is possible to apply a logic level to more than one of the inputs A . . . D at the same time. Because of the equal values of presets P1 . . . P4, a four-bit digital-to-analog converter is then formed which allows up to sixteen fixed speeds. At 0000 only P1 in the disco lights circuit determines the speed.

2

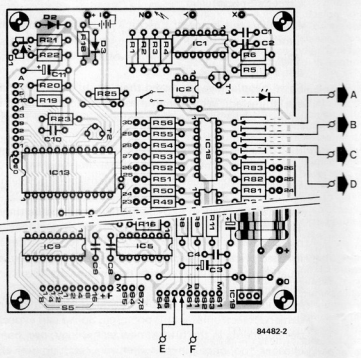

84482-2

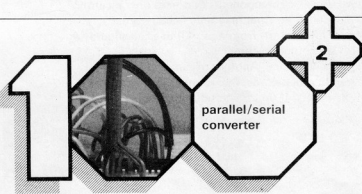

parallel/serial converter

keyboard adapter

Parallel/serial converters have a variety of applications in computer technology, for instance, in interface circuits for printers with a serial input, or as adapter for a keyboard

with parallel output when the computer has one or more serial, but no more parallel, interfaces available. The circuit is based on four LSTTL ICs: a four-bit synchronous binary counter, IC1, a parallel-load eight-bit shift register, IC2, a quad two-input

NAND gate, IC3, and a quad two-input NOR gate, IC4. As the circuit contains neither time-dependent nor discrete elements, you'll have to take care of its control by the system yourself.

In the quiescent state, the binary counter is set to 1010 (decimal 10). This condition is decoded by NAND gates N1 . . . N3 and NOR gate N7 into a stop signal for the counter (the output of N3 = ENABLE input - pin 10 - of IC1 = logic 0). The output of N3 is logic 1 for all other input combinations to N1 and N7.

The shift register is inhibited by the logic high level on output Q_D (pin 11) of IC1. A logic low input at input \bar{LD} (XMT) actuates the conversion process. The counter is then switched to binary input 1110 (decimal 14) and

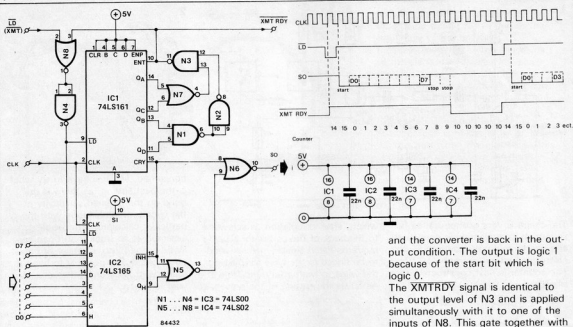

at the same time the register shifts the data to output Q_H (pin 9). After \overline{LD} has become high again, the leading edge of the next clock pulse switches the counter to 1111 (decimal 15). The CRY (carry) output (pin 15) of the counter then goes high which causes the serial output, SO , to become logic 0 via $N5$ and $N6$. At the following clock pulse the counter proceeds to 0000 and this condition is retained during the next eight clock pulses, that is, until the

counter is switched to 0111 (decimal 7); output Q_D is logic 0 during this time. In this period $IC2$ releases the parallel-loaded data serially, that is, one bit per clock pulse. At the ninth clock pulse, the counter proceeds to 1000 (decimal 8) and output Q_D becomes logic high again. The two following clock pulses cause $N5$ and $N6$ to pass the two stop bits (logic 1). The next counter position is 1010 (decimal 10)

and the converter is back in the output condition. The output is logic 1 because of the start bit which is logic 0. The $XMTRDY$ signal is identical to the output level of $N3$ and is applied simultaneously with it to one of the inputs of $N8$. This gate together with gate $N4$ forms an OR function. As the level of $XMTRDY$ is logic 1 during the data transfer, \overline{LD} pulses during that time have no effect whatever. The circuit works equally well with 8-bit or 7-bit plus parity bit information. If only 7-bit information is to be used, input $D7$ should be made permanently logic high: a third stop bit should not affect most systems one way or another. The current consumption of the converter amounts to about 70 mA. ■

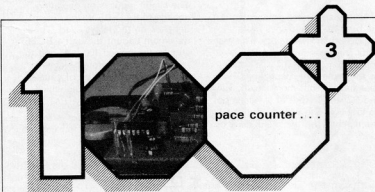

... counts jumps too!

For a change, here is a circuit which is primarily intended for sports people: it can count steps or jumps. From now on, whenever you go through a skipping session in training, this circuit can tell you precisely and at any moment how many jumps you have made. All you need is a cheap LCD (liquid crystal display) pocket calculator, a small piezo buzzer, a type 4066 CMOS IC, and a few other components.

First, the buzzer has to be prepared as it will serve as the measuring detector. Carefully cut away a strip of the plastic housing and glue a small piece of relatively heavy metal (lead or iron) onto the brass membrane (see figure 2). Because of the increased inertia of the modified membrane it bends at every step or jump. The consequent piezo voltage generated by the buzzer is applied to the input of the circuit. The piezo signal is amplified by darlington pair $T1$ and $T2$, the gain of which is preset by $P1$. When the

signal arrives at $T3$, it is converted into rectangular pulses which are used to control electronic switches $ES1$ and $ES2$. These switches form a monostable multivibrator whose delay is preset with $P2$. Any pulses arriving during the delay period have no effect whatever so that, for instance, noise pulses are effectively suppressed. Now comes the question, of course, how to get to the memory of the calculator. To that end, one of the keys of the calculator is connected in parallel with a third electronic switch, $ES3$. Which key of the calculator is taken depends on the calculator. With many calculators it suffices to input a constant by which the counter position is increased when the + or the $M+$ key is pressed. With yet other calculators, first the 1 and then the +, or $M+$, keys are pressed. If you buy a pocket calculator specially for this purpose, make sure that it is possible to increase the memory, and thus the LCD, by means of one key, by 1 (that is, the constant).

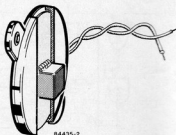
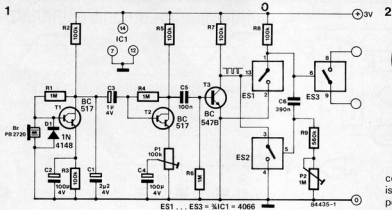

concerned, you will have to try what is the best setting, as this will depend on the required sensitivity of the circuit in combination with the particular calculator. The whole assembly is so small that it can easily be slipped into a trouser or breast pocket; it is also possible to hang it round your neck or fix it to one of your legs.

The circuit is very economical as far as current consumption is concerned and can therefore be powered by the calculator battery (normally +3 V). The counter is best constructed on a small piece of wiring (Vero) board

which, after completion, is screwed to the back of the calculator. The buzzer is fitted similarly. Holes need to be drilled in the case for passing the wires to the battery and from ES3. As far as the setting of the presets is

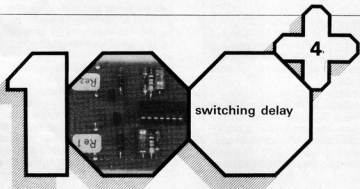

for filming and other applications

It is sometimes required that one of two parallel-operating units is switched on just after, and switched off just before, the other. An example is in film or camera work where the lights must be switched on just before the camera, and switched off just after it. The present circuit provides such a delay. Because the IC we used contains four NAND schmitt triggers, of which only two are needed for the delay circuit, we took the opportunity of providing a debouncing latch. In the circuit diagram, N1/N2 form the debouncing latch, and N3/N4 the delay circuit. Suppose that switch S1 is in the off position. The output of N2 is then low, capacitors C1 and C2 are discharged, and the outputs of N3 and N4 are high. The base potential of p-n-p transistors T1 and T2 is then almost equal to the emitter voltage so that the transistors are cut off and the relays, Re1 and Re2, are at rest.

When S1 is turned on, the output of N2 becomes high, and C2 is charged instantaneously via D3. The output

of N4 goes low and consequently the base of T2 becomes more negative than the emitter. This transistor then conducts and Re2 is actuated.

At the same time, capacitor C1 charges also, but more slowly, via D2 and R2; the output of N3 does not go low until the voltage across C1 has reached the threshold value of

the gate. When the level on pin 4 of N3 is low, T1 conducts, and Re1 is actuated.

When S1 is switched off again, C1 discharges instantaneously over D1, so that Re1 returns to rest at once. Capacitor C2 on the other hand discharges more slowly over R3 and D4 so that there is a noticeable delay before Re2 is deenergized.

The delay at switch-on depends on the time constant R2/C1, and that at switch-off on R3/C2. With the values shown, both are 2...3 seconds.

The circuit requires an operating voltage of 6...15 V; the current depends on the relays used. The maximum current through a BC 557 should not exceed 100 mA, and the relays should therefore be chosen with that in mind. It is, of course, possible to use transistors which allow a larger current.

from an idea by B. Willaert

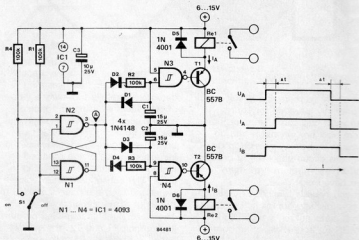

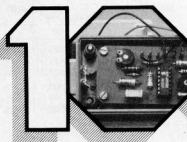

fridge alarm . . .

5

provides further optimization of the volume by tuning N3 to the resonant frequency of the buzzer.

Preset P1 determines the sensitivity of the alarm: the smaller its value, the less sensitive the circuit is.

The alarm is most conveniently constructed on the printed-circuit board shown in figure 2.

Current consumption in the quiescent condition is of the order of 0.5 mA and when the alarm operates about 4 mA.

from an idea by W. Groot Nueland

. . . protects tomorrow's dinner

As we all know, it is important that doors of fridges and freezers are normally closed. An alarm to tell you that it isn't is the subject of this article. It is based on a light-dependent resistor (LDR). As soon as the door of the fridge, or freezer, being guarded is opened, light falls onto the LDR: the circuit is then actuated and a warning tone is sounded until the door is closed again.

The circuit may also be used to monitor other doors (for instance, to prevent heat loss, or as a precaution against a fire spreading), but because of the ambient light it is of course impossible to use an LDR. This can therefore be replaced by a microswitch, in which case the alarm will sound when the switch is closed. Note that this requires a switch which closes when the door is opened.

A delay of about 10 s between the opening of the door and the sounding of the alarm is provided by the time constant R3C4. If faster reaction of the circuit is required, the value of R3 may be reduced to 220 k.

At the moment the threshold of N1 is exceeded, the gate commences to oscillate at a frequency of a few hertz. Each consequent rectangular pulse at the output (pin 3) of inverter N2 fires oscillator N3 which generates pulse trains whose rate amounts to a few kilohertz. The pulse trains are fed to inverter N4 which causes the piezo buzzer to emit a tone.

Without N2, oscillator N3 would work continuously when N1 is not being triggered: the output of N1 would then be high, and the logic 1 at pin 8 of N3 would cause the oscillator to function. Inverter N4 serves to amplify the output of the buzzer. If the buzzer would simply be connected between the output of N3 and earth, the membrane would merely move from its rest position to one side. By connecting the buzzer across an inverter, its polarity is constantly reversed and this causes a doubling of the alternating voltage across it. Preset P2

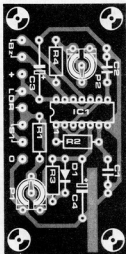
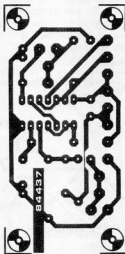
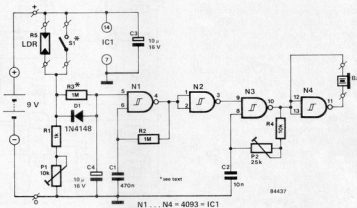

Parts list

Resistors:

- R1 = 1 k
- R2, R3 = 1 M (value of R3 may be reduced: see text)
- R4 = 10 k
- R5 = LDR
- P1 = preset 10 k
- P2 = preset 25 k

Capacitors:

- C1 = 470 n
- C2 = 10 n
- C3, C4 = 10 μ /16 V

Semiconductors:

- D1 = 1N4148
- IC1 = 4093

Miscellaneous:

- S1 = door (micro) switch
- piezo electric buzzer
- PP3 (9 V) battery with clips
- case 100 x 50 x 40 mm
- printed circuit 84437

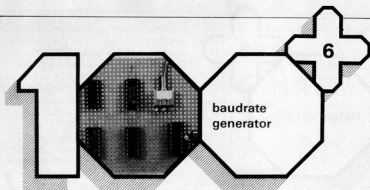

baudrate generator

Table

baud-rate	exact frequency (Hz)	measured frequency (Hz)	error
1200	19200	19229	0.15%
600	9600	9614	0.15%
300	4800	4807	0.15%
150	2400	2404	0.15%
110	1760	1748	0.68%
75	1200	1202	0.15%

with six switchable settings

Most asynchronous receiver/transmitters (generally known as UARTs) operate at a clock frequency which is sixteen times the transmission rate. There are special ICs available that are dedicated to this particular timing function but they are neither freely available nor cheap. The classic switchable oscillator/divider circuit is, however, a good substitute. The clock frequencies provided in the design shown here correspond to the standard transmission rates of 1200, 600, 300, 150, 110 and 75 baud. The oscillator is based on inverters N1 and N2, in combination with the 1 MHz crystal. Its signal is fed, via N3, to the first 4024. A flip-flop, consisting of N9 and N10, is included in the reset line to this divider to ensure that the reset is perfectly synchronised with the clock signal. The output signal from IC1 feeds the clock input of the second 4024, which can be 'programmed' by means of S1 (a double-pole six-way wafer switch). The reset pulse for this seven-stage binary counter is provided by N5, N7

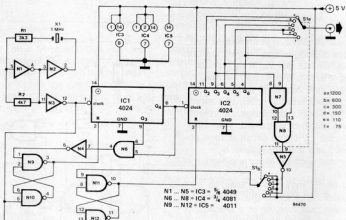

and N8 and travels via a second synchronising flip-flop (N11/N12), which is, once again, clocked by the oscillator signal. The 'programming' switch, S1, can be replaced by a pair of wire jumpers in the appropriate places if one baudrate is continuously selected. The table here indicates the frequencies measured in our prototype corresponding to the various baudrates.

The exact frequencies anticipated are also given in order to show that the error is negligible in all cases. The principle used in this circuit could quite easily be extended to make it suitable for a different crystal than the one stated. It will then be possible to make use of an 'old' crystal instead of having to buy one.

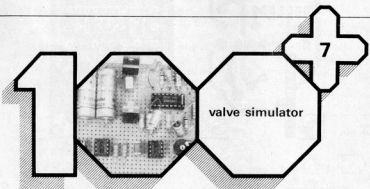

valve simulator

for good-old-fashioned radio noise

Nostalgia is becoming ever more of a 'big business'. This is understandable as we all have a tendency to remember 'the good old days' when life was simpler, less complicated, and everybody was happy. In reality, of course, it was quite different but we often prefer to let our minds play tricks on us so we only remember

the good things. Part of the nostalgia for many electronic hobbyists has to be the original valve radios. They were a breed apart, with the way they looked and the sounds they made, and it was impossible not to be taken in by their magic. Many antics still hide these radios, which no longer work, so we thought it would be interesting to fit a transistor radio into one of these old cases and add

a bit of 'magic' of our own. Then your modern radio is guaranteed to make genuine 'antique' noises and it even takes a while to warm up just like valves always do.

The circuit is based on two operational transconductance amplifiers (OTA), one of which, IC1, transmits the 'valve' hum while the other, IC2, transmits the audio signal that goes to the final amplifier. The outputs of the two OTAs are connected together so that the amplifier they feed receives a mixture of two signals. The volume of the hum, which is taken from the transformer's secondary winding, can be set with preset P1 and the signal level is set with P2. The gain of each OTA is determined by the bias current applied to pin 5 of the IC. The actual 'valve' sequence of silence — loud hum — hum becoming quieter — rising sound is generated by two monostable multivibrators. When the supply is switched on

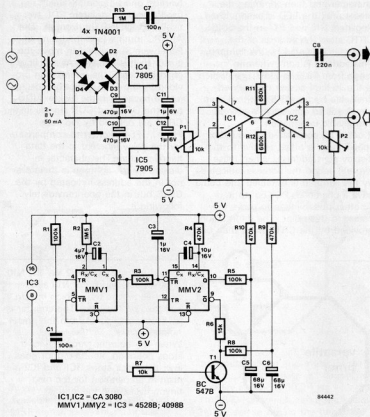

MMV1 is first triggered via R1 and C1, with the result that the Q output goes high. At the same time transistor T1 prevents any bias current from being passed to IC2 so no audio signals are transmitted by this OTA. The Q output of MMV2 is still low so IC1 also receives no bias current and only silence is heard. After about seven seconds the Q output of MMV1 goes low again so MMV2 is triggered. Its Q output goes high causing the bias current fed to IC1 via the R5/C5 combination to increase gradually. Even though T1 is no longer conducting the '0' level at the Q output of MMV2 prevents IC2 from transmitting the audio signal for the time being. After about five seconds the output of MMV2 changes so that Q becomes '0' and Q becomes '1'. The amplification of IC1 then drops slowly and that of IC2 rises slowly. Because of this the hum reduces gradually and the sound (music, or whatever) increases gradually until it finally drowns out the hum.

The symmetrical power supply for the circuit is based on a pair of voltage regulators, IC4 and IC5. Current consumption is less than 10 mA so the circuit could be powered from the existing supply in the radio. If this is done do not forget the connection from the secondary winding of the transformer to provide the hum.

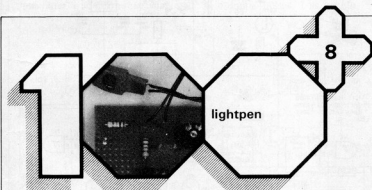

helps a computer to get to the point

A light pen is a tool that allows the coordinates of a point on the screen to be entered into a computer. It is based on the principle of sending a pulse to the screen control circuit at the precise moment when it sweeps the spot just in front of the lightpen. In the case of the Elektor VDU card the screen is controlled by a 6845; when this IC's LPEN input (pin 3) goes from '0' to '1' it loads the address of the character it is writing into registers 16 and 17. We will see later what can be done with this information.

The sensor in the lightpen is a partly.

covered light dependent resistor (LDR), the exposed part of which

1a

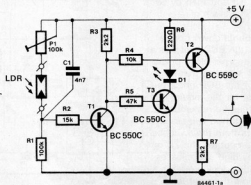

forms a window the same size as a character on the screen. When the electron beam in the screen passes in front of this window the LDR's resistance reduces drastically. This causes transistor T1 to conduct, followed by T2, with the result that a pulse suitable for the LPEN input of the CRTC appears at the collector of the BC 559. As soon as this latter transistor saturates T3 switches off and the LED extinguishes, indicating that the lightpen is correctly pointed at the character. For correct operation of the lightpen, preset P1 must be "calibrated". This is done by placing the LDR, which is screened

1b

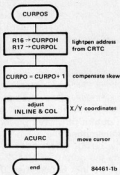

as shown in the sketch, in front of a character and then trimming the preset until the LED is extinguished. Registers R16 and R17 in the 6845 CRTC store the address of the character indicated by the lightpen. This address is somewhere in the range from 0000 to 3FFF_{HEX}, which is the 16 K of screen memory addressable by the 6845. All that then remains is to convert this address into usable information. It could be considered as an index specifying the offset relative to the display start address. When these two are added the address indicated by the lightpen is obtained and could have a character 'POKEd' to it. Another possibility is to move the cursor to this point. The information provided by the CRTC must then be

converted to X and Y coordinates (vertical and horizontal) which are used to modify pointers COL (vertical) and INLINE (horizontal). The ACURC routine (see the listing in Paperware 3) is called to move the cursor to this address. As the flow chart indicates, the information provided by the CRTC must be corrected because in the Elektor VDU card the DEN and CUR signals in the CRTC are delayed by flip-flops FF1...FF4 in order to compensate for the delay inherent in the data handling chain. The character indicated by the lightpen is therefore not in the address indicated by the CRTC but in the one immediately following it. **M**

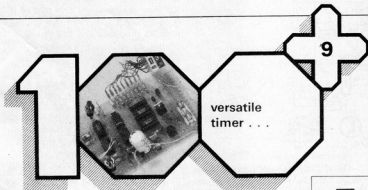

versatile timer . . .

. . . programmable from seconds to years

The timer described uses few components but yet has a relatively wide timing range which may be programmed by BCD thumb-wheel switches. The circuit may be modified to cater for even longer periods than shown, up to years if required.

The circuit consists basically of a clock generator and a presettable BCD down counter. The master clock is derived from the output of the bridge rectifier. This voltage is stabilized at 5 V by a zener diode and then applied to schmitt-trigger N9 to produce a pulse train of 100 Hz. The pulse train is first divided by 100 in IC1 and then by 60 in IC2 to give a final clock of 1 pulse/min.

Counter IC3 counts down from a number set by the BCD switches at a rate of one step per clock pulse. Ordinary SPST switches may be used instead of the BCD ones, but the binary code for the required time interval must then be remembered. When the start button is pressed, the parallel data from the switches is loaded into the counter, the ZD output of IC3 goes high and releases the inhibit on the clock input via N5. At the same time the reset is re-

moved from IC1 and IC2 via N1, N10, and N3. The output of N10 also switches on the triac which in turn switches on the load. The counter is then counting down from the preset number.

When the counter reaches zero, it stops counting, its ZD output goes low, the clock stops, IC1 and IC2 are reset in preparation for the next timing cycle, and the load is switched off.

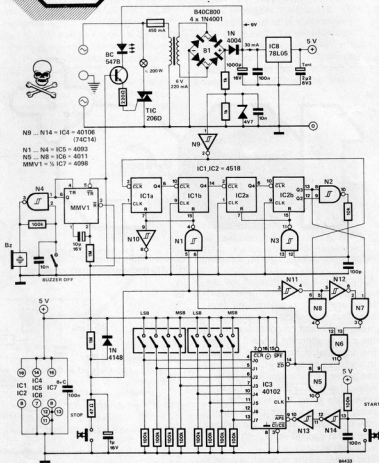

The output of N10 also triggers monostable MMV which then switches on a simple oscillator based on N4 and the buzzer sounds, provided the switch is closed. The circuit is self-setting, that is, when power is switched on, it automatically resets to the stop condition in preparation for the forthcoming timing cycle. To this end, the 100 Hz signal at the output of N9 is

passed to the clock input of IC3 which counts down to zero very rapidly. The ZD output (low) subsequently resets IC1 and IC2. Pressing the stop switch to abort a timing cycle has the same effect as power on. The timing range may be expanded or shortened by adding or omitting one or more 4518 counters. The count-down cycle may be fixed per-

manently to a specific time lapse by replacing the BCD thumb-switches with hard-wiring at the J inputs of IC3. As there are a lot of spikes in this circuit, good decoupling is essential. A 100 nF capacitor should be provided directly across the supply pins of each IC.

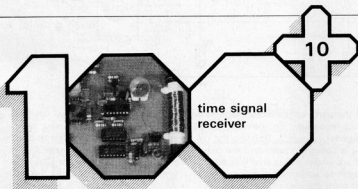

for France Inter

A very accurate time signal is available by tuning in to the Rugby MSF transmitter. This is not, however, the only such signal emitted into the air waves. A similar service is provided by the French long-wave station 'France Inter'. This transmitter is somewhat unusual as it

transmits talking and music as well as the second-pulses. Its carrier frequency is exactly 10.2^{14} Hz (163,840 Hz) which can quite easily be divided to obtain the time-base signal required. The time code transmitted by France Inter every minute contains binary information encoded by using a series of single and double pulses. This system

makes it easier for a modified radio to process the signal. The circuit described here can be used to receive the France Inter time signal almost anywhere in West Europe. The receiver was designed in such a way that it can be used to directly control a time-clock, such as the 6502 housekeeper described in the May 1982 issue of *Elektor U.K.* The input signal picked up by the aerial coil is first amplified before being fed to a mixer. Here it is combined with the signal from a 6553 kHz crystal oscillator whose frequency is divided by 40. The mixer's output signal, which has a frequency of about 60 Hz, passes to a PLL where a phase detector compares it to a 60 Hz VCO frequency. The difference between the two frequencies is taken as a correction signal that is used to control the VCO via a low-pass filter. The differences in question are the

1a

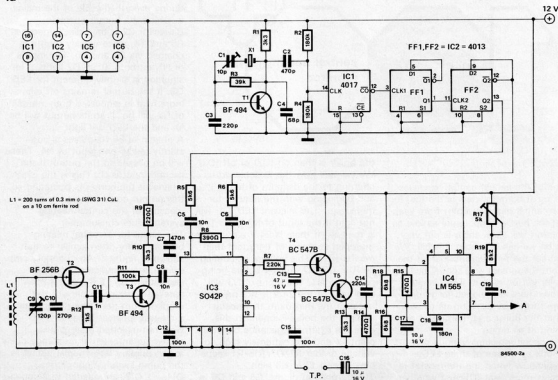

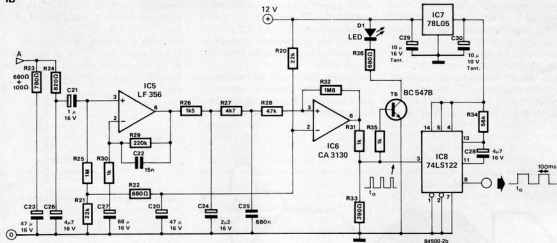

result of modulation of the input signal. Modulation of speech or music causes short frequency differences which are suppressed in the low-pass filter so the control signal for the VCO will be almost exclusively the result of the time-pulse modulation. This information is thus easily extracted by amplifying the signal, filtering it and then sending it via a trigger circuit to an MMV. Here the pulses are made suitable for the 6502 housekeeper, for instance, before being output from the circuit.

All the parts of the block diagram are easily recognised on the main circuit diagram of figure 2. Building the circuit is straightforward and the only remark about this is that it is advisable to screen off the oscillator (T1) from the rest of the circuit. After construction the receiver must be calibrated. Start by temporarily breaking the connection between pins 4 and 5 of IC4 and then connect a resistor of about 1 k Ω from pin 4 to ground. The frequency of the signal at pin 4 is then compared

with that at the test point (marked TP). This can be done using sensitive headphones to listen to the frequency and trimming preset R17 and/or trimmer capacitor C1 until both signals sound exactly the same. All that remains then is to set C9 in the receiver's input section so that the second-pulses heard at TP sound as loud as possible. Assuming everything else in the circuit is correct, LED D1 will now light each time a second-pulse is received. **M**

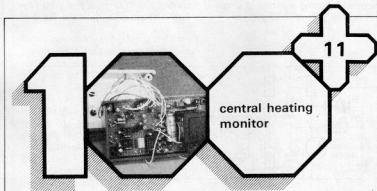

central heating monitor

with LED indication

One of the largest annual expenses for most home owners is the fuel for the central heating. Apart from keeping the house temperature as low as comfort will allow there is not very much we can do about this bill. We just set the temperature and let the room thermostat and central heating boiler get on with it. The circuit shown here is designed to go one step further by allowing us to see what the boiler and thermostat are doing at all times.

The circuit indicates various conditions by means of three LEDs. They show when the thermostat requests more heat (D1) and whether

the boiler is then on (D2) or off (D3). We will see how this is achieved by referring to the diagram of figure 1, and beginning with the request for more heat. The relevant LED, D1, will not light if the input of N3 is '1'. This is the case if there is 24 V a.c. across the open contacts of the room thermostat (RT). This voltage is rectified by R15, D7, R7 and C4 before being passed to N3. The input of N3 will also be '1' if the 24 V is not present because the maximum thermostat (MT) in the boiler is open. In this case the external resistance between points Y and Z is extremely high so voltage divider R7/D7/R15/R1 keeps pins 12 and 13 of N3 high. The purpose of diodes D5 and D6 is

to act as a current sensor, with the result that transistor T4 conducts during every half-cycle of the mains in which the burner operates. Capacitor C2 is then discharged, via R5 and T4, more quickly than it is charged via R4 and R5. The inputs of N1 are both '0' so D2 lights. The situation is slightly different for LED D3. If the burner remains off when more heat is requested both inputs of N2 will be '1' so its output will be '0' and the LED will light. A stream of 50 Hz pulses is constantly fed to one input of N4. These will be passed to the output if the second input is '1'. This is the case whenever the burner is operating so this output could be used as a measure of the central heating system's fuel consumption. The circuit for a central heating burner is very often similar to that shown in figure 2. An optional pump switch is also indicated. A 10 μ F capacitor (C6 = 6.8 μ and 3.3 μ in parallel) is added to prevent the monitor from permanently indicating a request for heat because if C6 were not included there would always be an external resistance due to the primary optocoupler circuit in the pump switch. Four diodes, D14 ... D17, are needed to compen-

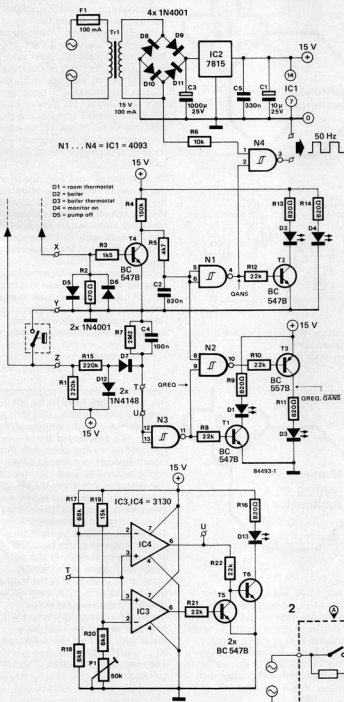

the window comparator circuit based on IC3 and IC4. The LED will then light whenever the pump switches on, if this is not a result of the thermostat requesting more heat, and then switches off again. The burner circuit is then on stand-by and there are only a few volts across the contacts of the room thermostat.

This central heating monitor can best be mounted close to the room thermostat. To install it first cut one of the two wires entering the thermostat (it doesn't matter which one), and connect this to X. One of the thermostat's terminals is now 'free' and should be linked to Y. The other terminal must be connected to Z by means of a length of wire.

If the central heating system contains a pump switch capacitor C6 and diodes D14...D17 must be included. It is strictly forbidden for any unauthorised person (i.e. you!) to make any changes within the central heating burner circuit. The monitor described here takes account of this and even when it is switched off it does not affect the working of the central heating system, because it is a totally passive circuit.

The behaviour of the central heating system can be changed using this monitor as it makes it possible to determine for how long the burner is on and off. Using the output of N1 as a clock signal for the event counter described elsewhere in this issue the number of burner on/off cycles can also be counted over a long period of time. On the basis of these two figures it is then possible to set the thermostat to its optimum value. ■

rate for the raised threshold in the same optocoupler (due to D5 and D6). It is worth noting that in some cases the voltage dropped across the wire running from the boiler to the thermostat is greater than the optocoupler's threshold voltage.

If a pump switch is included in your central heating system another LED, D13, can be added to the monitor. Replace the T-U link in figure 1 by

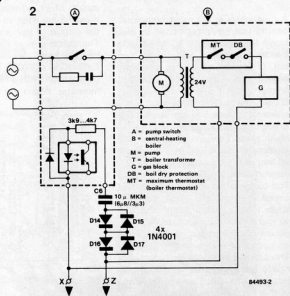

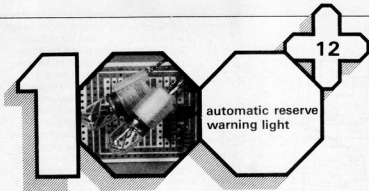

gives double protection

Warning lights fulfill an undeniably important role in many technical installations. However, even in the best of equipment, these lamps can fail. A glowing filament was never intended to have an indefinite lifespan. The circuit here cannot prevent the filament from failing, but it ensures that if the warning lamp cannot light, for whatever reason, a reserve light is automatically switched on. This secondary bulb, moreover, will only light when it is absolutely

automatic reserve warning light

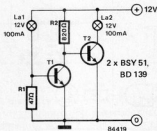

necessary, that is to indicate a fault in the equipment. Apart from the two lamps, the total

component count for this circuit is just two transistors and two resistors. The principle of the circuit is very simple: assuming there is a fault in the equipment, lamp La1 lights and a small part of the lamp's current flows to the base of T1, causing this transistor to conduct. As a result of this the base of T2 is effectively shorted to earth and this transistor cannot conduct. No current flows through the reserve light (La2) in the collector line of T2, so La2 is not lit.

As soon as La1 goes out, due to a bad contact, for example, or because the bulb is blown, the base current to T1 is cut off so this transistor immediately switches off. The current that flows through R2 then causes T2 to conduct and the reserve lamp lights.

Lamps which need a higher voltage than the 12 V given in our diagram can, of course, also be used in this circuit configuration. The components must then, however, be modified to suit the new situation.

ITT application

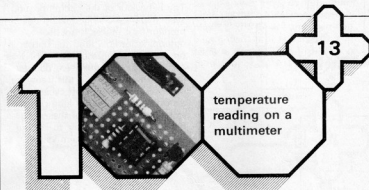

"How many volts above freezing is it?"

A multimeter is the most common item of test equipment used by electronic hobbyists. This is with good reason, considering how useful it is, but, of course, its abilities are fairly limited. Ask it about amps or volts or ohms and it is in its element. Broach the subject of degrees, however, and all you are likely to get is the multimeter equivalent of a blank stare. The versatility of a multimeter can easily be improved by adding the 'temperature-to-voltage' converter shown here.

The temperature sensor used in this circuit is an LM 335 which has a linear temperature characteristic of 10 mV/K. During manufacture this device is calibrated so that it gives an output of 2.73 V at 0°C (273 k). The LM 336 in the diagram is a very stable 2.5 V zener diode whose output is fed to IC2. The amplification of this CA 3040 can be varied

between 1.08 and 1.10 times, by means of P1, so this potentiometer must be adjusted to give 2.73 V at the output of IC2 when IC1 is at 0°C. The circuit is now calibrated at freezing point. Calibration at 100°C is carried out by comparison with an accurate thermometer. When the LM 335 is at

this temperature P2 must be adjusted to give a reading of 1 V between the output terminals of the circuit. The accuracy of the temperature reading given with this circuit depends to a certain extent on the multimeter used. The greater the resolution the better the accuracy. The connections to the meter must, of course, be reversed to read temperatures below 0°C. This circuit can also be used to enable temperatures to be measured in degrees Fahrenheit. In this case the freezing point adjustment is made at 32°F (2.73 V at the output of IC2). At 212°F, P2 is adjusted to give 0.9 V between the output terminals. One degree Fahrenheit is then represented by 5 mV, so a meter with 1 V f.s.d. will read from 32...232°F. The current consumption of the circuit is about 10 mA.

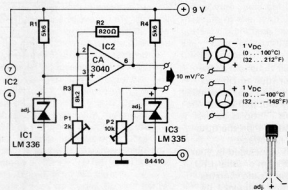

power supply monitor

more, in that case Z is linked to Y. If fuse F1 is used, however, Z is linked to X.

A ready-etched printed-circuit board is not available for the monitor, but a pcb may be made by yourself from the track layout given on the pc board pages.

Finally, please note that IC1 should be powered *before* the protected supply.

big brother is watching you . . .

This monitor circuit is based on the MC 3424 power supply supervisory IC. It provides two-channel over-voltage crowbar protection, which is very useful for floppy disk systems, and overvoltage and undervoltage monitoring of the +5 V line, which is particularly important in micro-processor supplies.

Each channel in the MC 3424 has an input and an output comparator.

Channel 1 is the undervoltage monitor, while channel 2 provides crowbar overvoltage protection. The input comparators sense the regulated supply line (pins 3 and 15). Each of them provides a common-mode range of 0 . . . ($V_{CC}-1.4$ V) volts. The source resistance of the inverting inputs determines the amount of hysteresis.

An on-chip generated reference voltage of 2.5 V (available at pin 1) is permanently connected to the non-inverting input (pin 2) of comparator 1 and to the inverting input (pin 14) of comparator 2.

When the voltage on the supply line drops below about 4.2 V, the input comparator of channel 1 (pins 2 and 3) changes state which causes a low logic level at pin 6 and the red LED, D1, lights. The LED could be replaced by an interrupt routine in the computer to safeguard stored data and to switch over to the back-up battery.

When the supply line rises above about 6.2 V, the input comparator in channel 2 (pins 14 and 15) changes state and pin 10 of IC1 becomes logic low. The silicon-controlled rectifier (SCR), Th1, then fires and short-circuits the supply to earth. Depending on whether the stabilized 5 V or the unstabilized line (A) is connected to the anode of Th1 (wire link XZ or YZ), the supply is cut off either by fuse F1 in the 5 V line blowing or the short-circuit across the smoothing capacitor in the protected power supply. Note that the 1N4001 diode in the protected supply is essential to safeguard the stabilizer.

If the protected power supply is already fitted with a fuse, a wire bridge should be soldered on the pc board instead of fuse F1. Further-

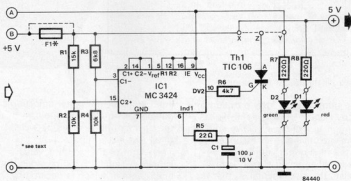
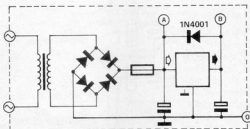

Parts list

Resistors:
R1 = 15 k
R2, R4 = 10 k
R3 = 6k8
R5 = 22
R6 = 4k7
R7, R8 = 220

Capacitors:
C1 = 100 μ F 16 V

Semiconductors:
D1 = LED, red
D2 = LED, green
IC1 = MC3424
Th1 = TIC106

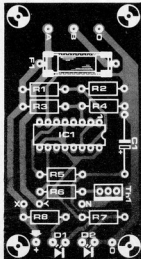
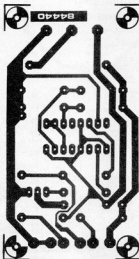

10



guitar preamplifier

15

the ratio of $R2 + R3 + P1$ to $R3 + P1$. The input impedance, which, at 1 M, is quite high, is defined by $R1$ as the op-amp has FET inputs. This is a suitable impedance for most guitar pick-ups. A 9 V battery provides the power supply which is converted to a symmetrical + and -4.5 V for the op-amp by means of $R4, R5, C3$, and $C4$. Current consumption is about 5 mA. The circuit complete with battery can easily be fitted into a small case. If a socket and plug are mounted in the

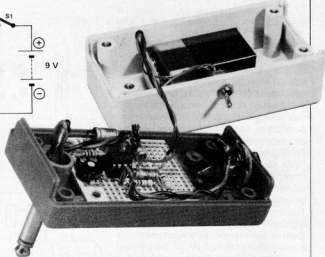
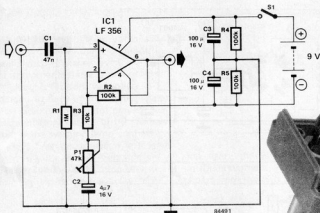

gives all the boost that is needed

The output signal level provided by many electric guitars is not high enough to overdrive a valve amplifier. This overdriving is an essential part of the final guitar sound. The preamplifier circuit shown here boosts the guitar signal so that the

input stage of the guitar amplifier is guaranteed to clip. As an aid to this the gain can be selected between three and eleven times.

The layout of the circuit is very simple. A single LF 356 provides the amplification, which is decided by

case, as the photo shows, the preamp can simply be plugged into the guitar. If this is done, preset P1 can be replaced by an ordinary potentiometer so that the amplification can be controlled by means of a knob on the case.

10

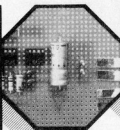

touch-pad potentiometer

16

an MKT type, charges via the skin resistance, which causes the output voltage of IC1 to drop linearly to zero. When the other touch-pad, Se2, is touched, the opposite happens: the output potential of IC1 will then rise linearly until it reaches the level of the supply voltage. The beauty of the circuit is that when you take your finger from the pad,

maintains the set value

Touch-pad keys normally use a simple digital memory, but they can be operated to give an analogue output voltage as is shown here in an inexpensive circuit that is easy to build.

The circuit is based on IC1, an operational amplifier with very high input impedance, which is connected as an integrator. When touch-pad Se1 is touched with a finger, capacitor C2,

1a

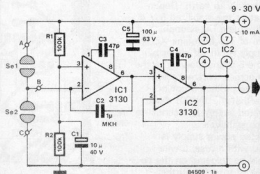

045029 - 1a

1b



the value of the voltage then present at the output of IC1 is maintained by the charge on C2. Owing to unavoidable leakage currents in the capacitor, the output voltage will, however, drift by about two per cent

per hour towards zero or towards the supply voltage, depending on which of the key pads was touched last. To keep these leakage currents small, it is necessary to keep the circuit well away from moisture or humidity, which should be borne in mind when choosing a case. The range of applications for this circuit is wide: it may be used anywhere there is a potentiometer that can be controlled by a variable

voltage.

If you prefer to use normal push button switches instead of touch-pad types, figure 1b shows how to connect these in the circuit. Resistors R3 and R4 simulate the skin resistance; switches S1 and S2 provide the input voltage for IC1. Pressing the switches simultaneously has no effect. Capacitors C3 and C4 obviate any tendency of the operational amplifier to oscillate. **K**

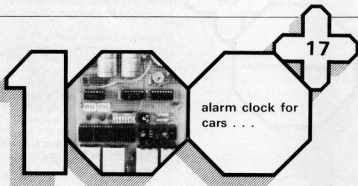

alarm clock for cars . . .

... for sleepy drivers

radio can be switched on and off via a relay contact.

The circuit is based on the MM 5387A, a relatively new (though readily available) IC which drives LED displays directly.

For use in a car, a quartz controlled time base is provided around IC2/IC3. The crystal frequency of 3.2768 MHz is divided to a final clock frequency of 50 Hz. If mains operation is used, this part of the circuit may be omitted and the mains frequency used as clock (the mains must, of course, be isolated from the circuit by, for instance, an optoisolator).

The circuit around IC4 is basically a regulator which controls the brightness of the displays. It should be noted that only one of the cathodes of each display needs to be connected. Diodes D4 and D5 form the flashing colon between LD2 and LD3. Because the clock is operated in the 12-hour mode, diodes D2 and D3 indicate forenoon (a.m.) and afternoon (p.m.) respectively. The car battery voltage is stabilized by R3, L1, C4 and C5, while zener D1 protects the CMOS-ICs. In mains operation, the rectified voltage may be applied directly across C4 (transformer to be used: secondary 12 V, 400 mA; R3, L1, and C5 may be omitted).

The alarm is built around N1 . . . N4. A 1 kHz signal is taken from oscillator IC3 (pin 1) and modulated with a 1 Hz signal from IC1 (pin 39) in N4. The ALARM OUT switches the alarm on and off via N3.

The SLEEP output is buffered by T1 and relay Re so that, for instance, a

Setting up

Switch on the supply; the display should then flash.

Setting the time: ensure that switches S1 . . . S8 are open. The time can then be set with S6 (fast) and S7 (low).

Setting the alarm: set as time but with S5 closed in addition. Make sure that the switches are opened again after setting, and remember a.m. and p.m.

Setting sleep time: close S3 when the display will read 00:59. This time may be shortened by pressing S6 and/or S7. As long as S3 is closed,

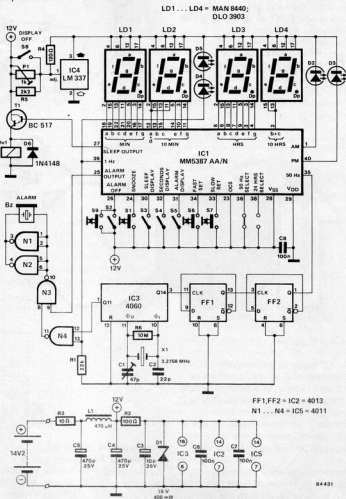

FF1, FF2 = IC2 = 4013
N1 . . . N4 = IC5 = 4011

B4431

relay Re is actuated until either the indicated time has lapsed or S1 is pressed.

Indicating seconds: close S4.

Alarm: when the alarm goes off, it may be stopped with S9 or S2.

Keeping S2 closed disables the alarm permanently. Pressing S1 stops the

alarm temporarily: after 8...9 minutes it goes off anew. If the alarm is not switched off manually, it stops automatically after 59 minutes.

If the clock is used without a crystal time base, an external 1 kHz signal must be provided for N4, otherwise the alarm does not work.

To reduce power consumption (particularly in cars), it is possible to switch off the display with S8. This switch may be combined with the ignition switch. Current consumption with the display on is about 200 mA, dropping to about 20 mA when the display is switched off.

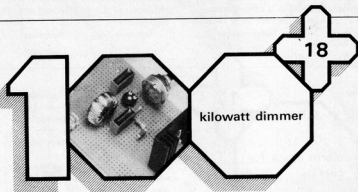

a tried and tested formula

Most light dimmers that are available in the usual electrical goods shops can only handle a fairly small power. A couple of hundred watts is generally the limit and the chance of finding one that can go up to a half kilowatt or so is slim.

The simple dimmer circuit shown here can control a power of up to 1 kW. There is not very much to be said about the contents of the circuit. It consists of one triac, one diac and an RC network in which

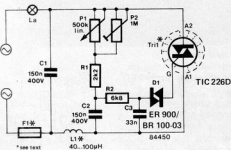

the charging and discharging times of capacitor C2 can be set with potentiometer P1. Noise spikes are suppressed by capacitor C1 and coil L1. Calibration involves setting P1 to maximum resistance and the trimming preset P2 so that the lamp is just extinguished. If a lamp of more than 100 W is used the triac must be mounted on a heatsink with a heat transfer rate of about 6 °C/W. For a 1000 W dimmer, suppressor coil L1 must be rated at 5 A (its inductance is about 40μH) and fuse F1 must be rated at 6.3 amps.

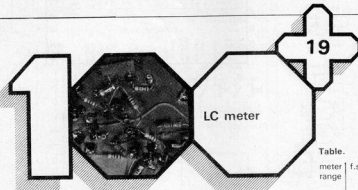

with moving-coil instrument

An LC meter is undoubtedly indispensable to anyone involved in h.f. techniques. The present design accepts the unknown inductance, L_x , or capacitance, C_x , in a two-transistor oscillator circuit, of which the output voltage is kept constant between 30 and 40 mV by a regulator.

When, in the oscillator circuit, C_x is connected in parallel with capacitor C_0 , or L_x in series with inductor L_0 ,

the frequency of the circuit diminishes. This diminution is measured by a frequency-to-voltage converter, T3/T4. The consequent output voltage of emitter follower T5

is used to actuate meter M1. Meter M1 is connected at the diagonals of a bridge circuit, so that it indicates zero in the absence of C_x or L_x . The meter is set to full-scale deflection (f.s.d.) by P2 when either $L_x = L_0$ or $C_x = C_0$ is inserted into the oscillator circuit. The tolerance of

Table.

meter range	f.s.d.	L_0	C_0	C_L	f_0	f_x at $C_x = C_0$ or $L_x = L_0$
		mH	nF	nF	kHz	kHz
1	100 pF	1	0.1	0.1	502	355
2	1 nF	1	1	0.33	158	112
3	10 nF	10	10	3.3	15.8	11.2
4	100 nF	100	100	3.3	5.02	3.55
5	10 μH	0.01	10	0.1	502	355
6	100 μH	0.1	10	0.33	158	112
7	1 mH	1	10	1	50.2	35.5
8	10 mH	10	10	3.3	15.8	11.2
9	100 mH	100	10	3.3	5.02	3.55

frequency-determining capacitor C_L in the frequency-to-voltage converter is balanced out by P1. It is therefore necessary to switch in a different 10 k preset for each measuring

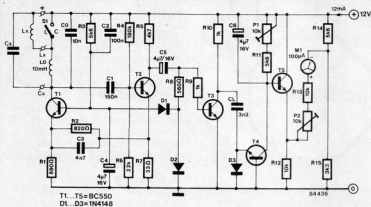

range, and whenever that is done the f.s.d. should be set afresh with P2. The values given in the circuit for L_D and C_D are valid for an f.s.d. of 10 nF or 10 mH. A maximum of nine

measuring ranges may be provided by means of a 4-wafer, 9-position rotary switch. The values of L_D , C_D , C_L , and the resulting frequency, without L_X or C_X at full-scale

deflection, are given in the table. The accuracy of the measurements, given careful calibration, is about 3 per cent.

Graduation of the scale is near enough equal for all ranges, but is 'stretched' by a factor of about 3 for low readings. This needs, of course, an appropriate correction.

Calibrating the scale may be carried out with a table compiled with the formula $n_i = n_m (1 - f_r) / (1 - f_c)$, where

n_i = number of scale divisions indicated

n_m = number of scale divisions at f.s.d.

f_r = relative frequency

f_c = lowest relative frequency

Total current consumption amounts to about 12 mA at 12 V.

ITT Application

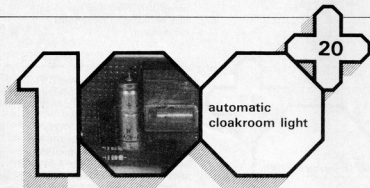

to help your guests

This circuit should put an end to your guests fumbling for the light switch in the cloakroom. It ensures automatically that the light is switched on as soon as someone enters the cloakroom and is switched off again when that person leaves. The principle of the circuit is fairly simple. The bistables in a 4013 CMOS IC are connected in series. One, FF2, is arranged as an R-S latch to debounce the switch. This

switch, S1, must change over as soon as the door is opened and is therefore best located in the door-frame. When the door is opened, FF2 is set and its output (pin 13) goes therefore high. This clocks FF1 on pin 3 and this bistable toggles: its output goes high and this switches on transistor T1. The transistor current actuates a relay and the light is switched on. When the door is closed, nothing happens because FF2 is reset and its output on pin 13 goes low. It's only when the door is

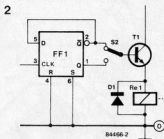

opened again that FF1 changes state: pin 13 then goes high and this causes FF1 to toggle. The output at pin 1 then goes low and cuts off the

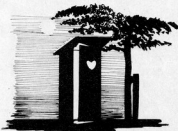

transistor so that the relay is deenergized and the light goes out. The relay should operate from voltages between 5 and 15 V. Because the door may be opened and closed without anyone entering, it is possible that the light gets out of step with requirements. This can, of course, be remedied by opening and shutting the door again, but a better way is to connect a second switch, S2, as shown in figure 2. This switch reverses FF1 and brings matters back into step. The circuit diagram in figure 1 shows S1 in position 'door open' and bistable FF2 is then set.

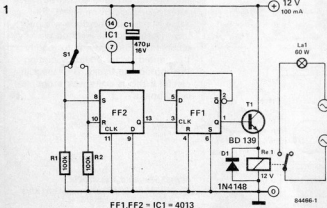

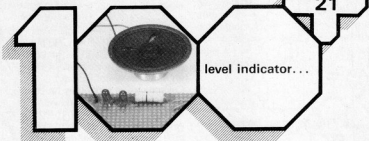

level indicator...

... for cassette interface

Compact cassettes, because of their low cost and easy availability, have been the mainstay memory in personal and hobby computers for

almost as long as these have been available. These cassettes convert digital computer data into audio signals and vice versa. They can, however, not prevent drop-outs caused by wrongly set signal levels.

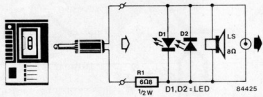

The present level indicator can help to prevent these mishaps. All that's needed to build the indicator is a 3.5 mm jack plug, two LEDs, a resistor, small loudspeaker, and a jack socket. The LEDs are connected in anti-parallel. The loudspeaker serves as a monitor to indicate whether the recorder is emitting signals (audible as two quite distinct tones), or whether the cassette content is between two programmes (when only a slight hiss is heard).

The indicator is connected to the ear-piece socket on the recorder by the jack plug and the cassette interface input via the coaxial socket. Most cassette interfaces need a signal level of 2 V_{pp}. When the signal provided by the recorder is at about this level, the LEDs begin to flicker; if the level is too high, they light continuously.

If the loudspeaker volume is too high, connect a 100 Ω preset in series with it, so that the volume may be adjusted to personal requirement.

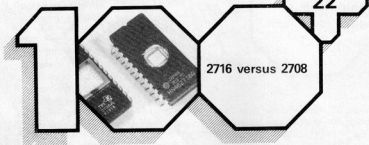

2716 versus 2708

how to double your ROM memory capacity

The 2708 EPROM has become virtually obsolete, and with good reason. It needs three supply voltages for its capacity of 1024 × 8 bits whereas its immediate successor, the 2716, uses the same 24-pin package but only needs a single supply voltage for twice the memory capacity (2048 × 8 bits). Furthermore, the 2708 has become so difficult to find that it has become more expensive than the 2716, and that alone is reason enough to consider the modifications needed to substitute one for the other. Fortunately, few changes are required as the address decoding remains the same. Most of the 2716 pins are directly compatible with those on the 2708 that they replace. The following pins are, however, worthy of note:

- Pin 21 (-5 V on the 2708) must be connected to +5 V for the 2716.

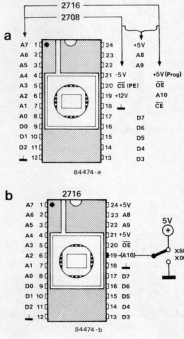

- Pin 20, incorrectly called \overline{CS} (chip select) on the 2708 while its function is actually \overline{OE} (output enable), retains the same function.

- Pin 19 (+12 V on the 2708) becomes address input A10 for the 2716. Depending on the logic level on this pin either the first or second 1 K block is selected. A switch could be used for this so if the EPROM contains a monitor, for example, two different versions of the same software could be stored in the same IC.

- Pin 18, which is connected to ground for the 2708, need not be changed for the 2716 (\overline{CE} , chip enable); note in passing that the 2716 will then never achieve the minimum power dissipation of 132 mW (stand by current).

There are several different ways of carrying out these modifications. An intermediary IC socket could be used with the pins that are to be changed not inserted into the socket but wired separately. If preferred, the same thing could be done without using a socket. The method we recommend, however, is to modify the printed circuit board by cutting the appropriate tracks. Be especially careful if this is done with a double-sided board.

Note: See also the article '2 × 2716 = 2732' elsewhere in this issue.

μ P infra-red interface

transmits serial computer information

In general the normal connections between a computer and its peripherals are very effective but these cables could hardly be considered decorative. A cable carrying serial information can, however, be replaced by this infra-red interface even though it only consists of a simple transmitter and receiver.

As figure 1 shows, the transmitter uses a single BC 557B transistor to drive the infra-red LED. The transistor is itself controlled by the micro-processor so a short program is required to make the computer generate the transmitter signals needed. The frequencies used here are 4800 and 9600 Hz and the maximum baud rate at these frequencies is 1200 baud.

The receiver, seen in figure 2, makes use of an IC (the SL486) especially developed for infra-red applications. This contains several gain stages, a pulse-width expander, and a voltage regulator. The receiver diode (D1) is connected directly to the IC. The stretch output, pin 11, is connected

to the low-pass filter made up of R1, R2, C9, and C10 and this, in turn, feeds schmitt trigger IC2. The decoded data is then available at the output of this IC.

When fitting the components to the printed circuit boards shown in

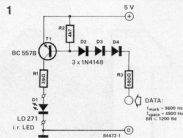
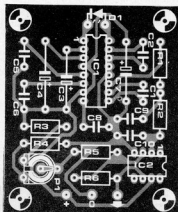
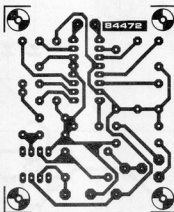
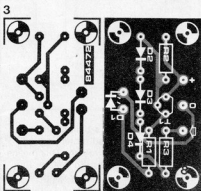
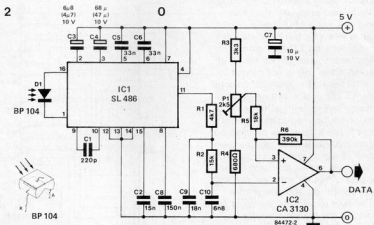

figure 3 it is important to remember that the leads for the receiver diode should be kept as short as possible. The 5 V supply for the boards can be taken from the computer or peripheral device. The only calibration needed concerns preset P1 which must be trimmed so that the data is received with no errors.



Parts list

— Transmitter

Resistors:
R1 = 39 Ω
R2 = 4k7
R3 = 680 Ω

Semiconductors:

D1 = infra-red LED, e.g.
LD 271
D2 ... D4 = 1N4148
T1 = BC 557B

Parts list — Receiver

Resistors:
R1 = 4k7
R2 = 15 k
R3 = 3k3
R4 = 680 Ω
R5 = 18 k
R6 = 390 k
P1 = 2k5 preset

Capacitors:
C1 = 220 p

C2 = 15 n
C3 = 68µ (4µ7)/10 V
C4 = 68µ (47 µ)/10 V
C5, C6 = 33 n
C7 = 10 µ/10 V
C8 = 150 n
C9 = 18 n
C10 = 6n8

Semiconductors:

D1 = infra-red detector,
e.g. BP 104
IC1 = SL 486
IC2 = CA 3130

24

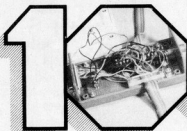

twin RS 232

a two-into-one or one-into-two RS 232 link

The D-type connectors generally used for RS 232 interfaces are quite robust and are well able to take the wear and tear that comes with frequently being inserted and removed. The human computer user can, however, get a bit frayed around the edges when he has to change his computer's RS 232 lead from one peripheral to another for the umpteenth time. This is not helped by the fact that, for aesthetic reasons, the RS 232 port is almost invariably located out of sight at the back of the computer. Fortunately, many people never have this problem but none the less it does crop up fairly often: such as when a computer, terminal, and printer are used together, or one computer and two printers, or two computers and one printer. In answer to an unspoken plea for a cure for this situation we have designed what is, in effect, an RS 232 single-pole two-way switch. The interesting part of the circuit is the two high-efficiency LEDs connected to four of the interface's data transfer lines. The (red or yellow) LED corresponding to the channel in use flickers when data is passing through the lines so that would be a bad time to switch to the other channel. After the LED stops flicker-

ing data transfer is over so the other channel can be selected and its LED will light immediately.

You may be wondering why the LEDs are needed and why it is not

possible simply to switch from one channel to the other at any time. To see why we will have a look at what happens if the switch is opened, even momentarily, while data transfer is under way. The logic levels are then undefined for a short period of time, which is clearly a very bad idea. Many RS 232 interfaces, fortunately, are fitted with MC 1488/1489 ICs which always have a defined logic level at the inputs even when any of the inputs is connected to nothing (floating).

The numbering indicated in the diagram here corresponds to a 25-pin D-type connector. The designations of the RS 232 lines can be found on Elektor infocard 64, if you feel the need to refresh your memory.

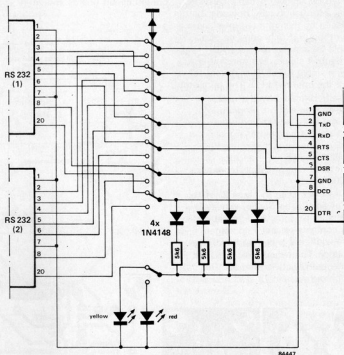

25

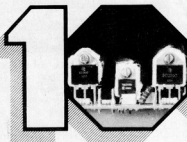

small high-power amplifier

at least 120 W into 4 Ω

The TDA 2030, made by SGS Ates, is a complete amplifier contained in a

single IC with a five-pin Pentawatt package. Its class AB output stage can provide a power of 14 W into 4 Ω at a supply voltage of ± 14 V.

The amplifier has a built-in short-circuit and overload protection, and also a thermal shutdown. This means that it is not so easy to destroy the IC as long as the supply voltage is kept below the absolute maximum of ± 18 V.

Combining two 2030s with a few inexpensive power transistors can form an amplifier that can drive quite a lot of power into a load of 2 to 4 Ω . As the diagram shows, the circuit is a standard 'bridge' amplifier so there is little to be said about it. Each half of the bridge consists of a TDA 2030 driving two complementary power transistors. The diodes, D1...D4, are needed to protect the transistors from the loudspeaker coil's inductive

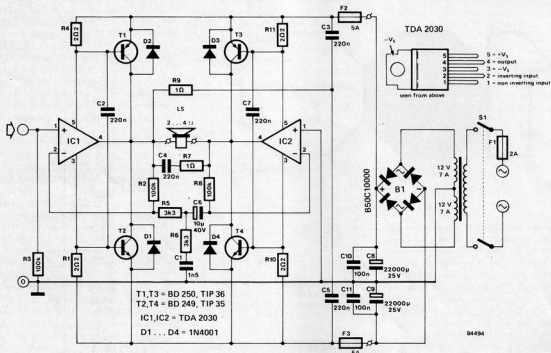

voltage. The gain of the whole amplifier is defined by:
 $A = 1 + (R2/R5) + (R8/R5)$
 With the values stated this works out at 32 dB. If the gain is to be changed it must be remembered that

R2 and R8 must have the same value. The load on the amplifier may also be 2 Ω rather than the more normal 4 Ω if the power transistors stated are used. With a suitable power

supply the amplifier can then provide up to 200 W. Large heat sinks are essential, especially in this latter case. The only characteristic we will quote is the distortion, which, at less than 1%, is quite acceptable. **M**

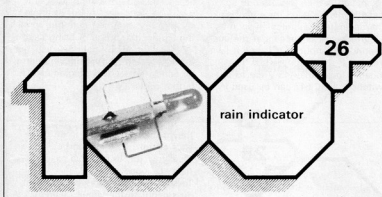

a meteorological LED

In spite of all their sophisticated weather-predicting equipment, meteorological services around the world have a reputation for not always getting it right (to put it mildly!). Because of this many people try to predict the weather themselves as much as possible. They vigilantly tap the barometer every morning and then rack their brains to remember whether high pressure means good weather or bad weather. Another favourite involves reciting rhymes about shepherds, but unfortunately this can be a little bit vague. What most people really want to know is 'will it rain today or not?'. That is exactly what this circuit can tell.



We will not go into the technical details of the circuit as we simply do not have the room for that here. Anybody who is interested, however, is advised to read the fourth volume of 'Zen and the art of inverse diffraction coefficients'. When the LED lights no rain is expected within the

Table

Prediction accuracy during the test period:	
England	80%
Scotland	89%
Wales	87%
N. Ireland	91%
Irish Republic	93%
Netherlands	85%
Germany	78%
France	71%

next twenty-four hours. If the LED is not lit it is wise to remember your raincoat and umbrella. The table given here shows just how accurate the circuit's predictions were during the test period last winter. A variation on this theme is to use a battery with a slightly higher voltage. The circuit must then be built in summer and the intensity of the LED's light indicates the probability of accuracy of the prediction. **M**

power switches for μ Ps

for computer-controlled d.c. powered equipment

It is not enough simply to own a micro computer, you must also know what to do with it. Having found an interesting field of application the next question will be 'how should it be done?'. The answer usually involves programming input/output circuits, or designing them. This can strike fear into the hearts of many users of computers that have rudimentary, or non-existent, input/output facilities. Fortunately, this fear is groundless and, as the circuit here shows, it is not at all difficult to use a computer to drive relays, electronic switches, and all sorts of lamps, motors, or whatever. The basis of this circuit is formed by the eight flip-flops contained in IC1. These are controlled by a positive pulse (for the 74LS373) or a rising edge (74LS374) and ensure that the output logic levels remain stable. The control signal applied to pin 11 could be obtained in several ways, such as via a programmable output port or by address decoding (see the articles

on this subject in the January and February issues of this year). The eight data entries D0 . . . D7 should be connected either directly to the processor's bus or to a second programmable output port. Each of the outputs, Q0 . . . Q7, controls a darlington (T1/T2) which can switch up to 60 V at up to 1 A. The power dissipation is then low enough so that there is no need for a heat sink. The darlington saturates as soon as a high logic level appears at the corresponding output of IC1, and it switches off if the output is low. If voltages lower than 45 V are to be switched, a BC 547 can be used in

place of the BC 546. A diode, D1, has been included as a protection against voltage spikes. This circuit is very flexible. If you do not want to use all eight outputs of IC1, the same IC is used but the number of darlings is reduced. Similarly, a number of ICs may be cascaded, with each IC driving up to

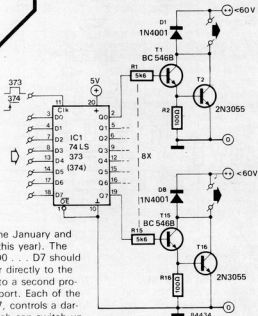

eight outputs. In this case they could be controlled by means of two output ports, with port A, for example, serving as a common data bus to all the flip-flops and port B being used to select the appropriate device. This would enable up to 64 darlings to be controlled via two programmable output ports.

VHF dipper

a simple resonant frequency meter

Way back when electronics was still young (shortly after the stone age) when grids, anodes and cathodes were all the rage, this device would have been called a grid dipper. Now it is more likely to be called a dip meter or a transistor dipper. No matter what it is called it is still the same instrument, and in the handy

transistorised form shown here it is an indispensable aid for any HF handyman.

Before we start describing the circuit, we must first establish exactly what a dip meter is. A dip meter could be considered as a sort of frequency meter whose purpose in life is to define the resonant frequency of LC circuits. The circuits do not have to 'radiate' (in other words,

they do not have to be in an oscillator circuit), as they can be measured, or, to be more exact, dipped, 'loose'.

To see how this works we can best go straight to the circuit diagram. The parts that make up a dip meter are always the same: a tunable oscillator, a rectifier and a moving coil meter. The oscillator here is based on T1 and T2, and is tuned by means of capacitor C1 and coil Lx. This coil is fitted outside the metal case into which the circuit must be built, and must be easily exchangeable for a different coil to enable the range to be changed.

When the dipper is switched on the oscillating voltage generated is rectified (by D1 and C2) and is then passed to the meter via P1, which adjusts the meter reading. Nothing unusual so far, but now comes the interesting bit. If Lx is inductively coupled with the coil of some other LC circuit, whose resonant frequency is the same as the oscillator fre-

quency of our dipper, this other coil will draw energy from the oscillator coil. The result is that the voltage across the meter drops and the reading is reduced.

What happens in practice is this: the dipper is switched on and P1 is adjusted so that the meter gives maximum, or almost maximum deflection. The coil of the LC circuit to be measured is now placed close to Lx and C1 is adjusted until the meter reading shows a clear 'dip'. The frequency can now be read off from the graduated scale on C1.

This graduation is where Murphy gets his hand in. A second, graduated, dip meter or — even better — a frequency meter is needed for this. With the layout shown here and using a free wound coil (without a former) of 2 turns of 1 mm (SWG 19) copper wire with a diameter of about 15 mm, the range of the dip meter is about 50 . . . 150 MHz. A coil could be wound on a DIN plug and a DIN socket mounted in the case of the dip meter to facilitate easy changing of the inductor.

A few points to note. The BF 494 transistors in the oscillator can only handle up to about 150 MHz. If higher frequencies are contemplated these transistors must be replaced by another type, such as the BFR 91, which should allow up to 250 MHz. There are various different possibilities that can be used for variable capacitor C1. It could, for example, be the 50 pF capacitor from the Jackson C804 range, or a cheaper solution is to use two 100 pF mica capacitors connected in series. Another possibility is to get hold of

an (old) four-gang FM tuning capacitor and link the four sections, each of which is about 10 to 14 pF, in parallel.

Finally: any dip meter, including this one, can, in principle, also be used as an absorption meter or field strength meter. To use it in this configuration, leave the voltage supply of the meter off and look not for a dip but rather for the maximum reading on the moving coil meter. **M**

P. Engel

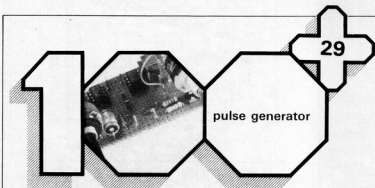
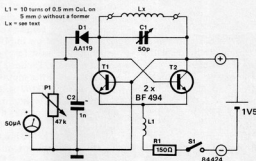

with variable pulse rate and pulse width

The generator presented is based on two 555-timer ICs and provides rectangular pulse trains (waves) of which the pulse width and the pulse rate are variable.

The first timer, IC1, is connected as an astable square-wave generator. Symmetry of waveform is maintained to within a few per cent by a stereo potentiometer and two diodes. Bear in mind that a square wave, by definition, is a rectangular wave with a 50 per cent duty factor, that is, its pulse width must be equal to half the pulse spacing. The frequency range is determined by switch-selective capacitors: with values as shown, it lies between 1 Hz and 100 kHz. Maximum output current of IC1 is 100 mA.

The trailing edge of the output

pulses from IC1 is used to trigger the second 555 which is connected as a monostable. This stage enables the

pulse width to be varied between 10 µs and 100 ms by switch-selective capacitors. Maximum output current of IC2 is also 100 mA.

Switches, potentiometers, and capacitors C1 . . . C5 and C9 . . . C13 may be replaced by single, fixed components if a pulse generator with predetermined parameters only is required.

The supply voltage may be between 5 . . . 12 V; the off-load current is about 10 mA.

It is advisable to use good-quality capacitors if optimum performance of the generator is to be realized. **M**

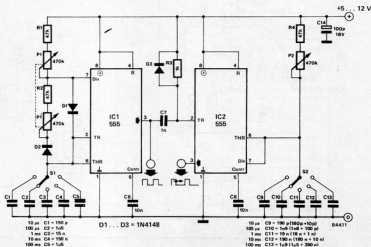

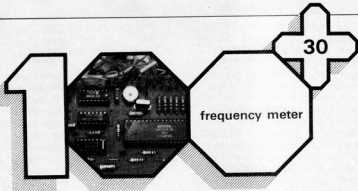

with good accuracy at low frequencies

Intersil IC type 7226B is just the right counter for a simple but reliable frequency meter which covers a range of 9 MHz. The circuit of the meter divides into four functional sections:

- input stage, T1, T2, N2, N3;
- multiplier, FF1, FF2, IC3, IC4;
- counter, IC5;
- display, LD1 . . . 6

In general, the circuit is a standard design, much of which has been described in earlier issues of *Elektor*. The primary function of the input

stage is converting the input signal into rectangular pulses that are fed to the counter either direct or via the multiplier. The stage can handle input voltages of up to 50 V r.m.s. which is sufficient for most measurements. Diodes D1 and D2 conduct when the input voltage is above about 600 mV so that the input impedance is determined primarily by the value of R2, that is, around 1 M. The multiplier ($\times 100$) is particularly important for the measurement of frequencies between 5 Hz and 1 . . . 2 kHz. The counter, the Intersil 7226B, con-

tains a crystal oscillator, a time base, a counter, a seven-segment decoder, a multiplexer, and a number of drivers for the direct control of the LED display.
In our prototype a 1 MHz crystal was used for driving the on-chip oscillator, but if D5 is omitted a (cheaper) 10 MHz crystal may be used. The LED display is the popular type MAN 4640A.
The function of the switches is:
■ S1a connects the input stage to the counter either direct or via the multiplier (as shown);
■ S1b ensures the correct position of the decimal point when the multiplier is in circuit;
■ S2 normally determines the position of the decimal point, that is, whether the display reads kHz or MHz;
■ S3 is the mains on/off switch;
■ S4 is the reset switch;
■ S5 serves to test the display: when it is pressed, all segments should light.
Finally, note that printed circuit 84462 for the meter has no provision for the display; this may be fitted on board 80089-2 originally designed for the Junior Computer. ■

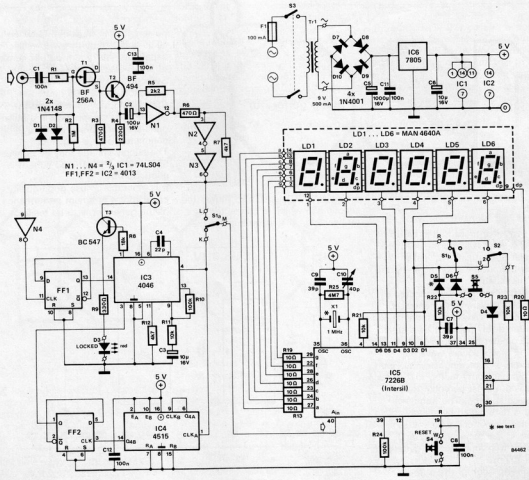

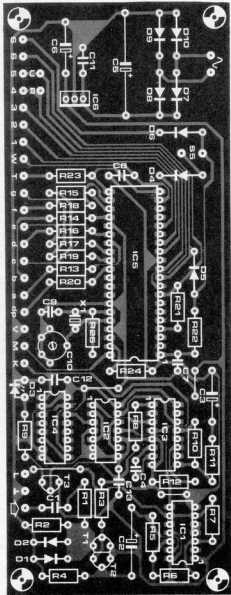
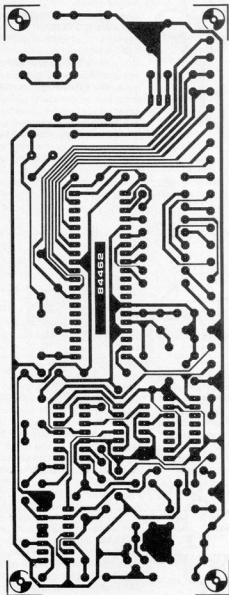

Parts list

Resistors:

R1 = 1 k
 R2 = 1 M
 R3, R6 = 470 Ω
 R4 = 220 Ω
 R5 = 2k2
 R7, R12 = 4k7
 R8 = 18 k
 R9 = 330 Ω
 R10, R24 = 100 k
 R11, R21 ... R23 = 10 k
 R13 ... R20 = 10 Ω
 R25 = 4M7

Capacitors:

C1, C8, C11 ... C13 =
 100 n
 C2 = 100 μ /16 V
 C3, C6 = 10 μ /16 V
 C4 = 22 p
 C5 = 1000 μ /16 V
 C7, C9 = 39 p
 C10 = 40 p trimmer

Semiconductors:

D1, D2, D4 ... D6 =
 1N4148 (for D5 see text)
 D3 = LED (red)
 D7 ... D10 = 1N4001
 T1 = BF 256A
 T2 = BF 494
 T3 = BC 547
 IC1 = 74LS04
 IC2 = 4013
 IC3 = 4046
 IC4 = 4518
 IC5 = 7226B (Intersil)
 IC6 = 7805
 Ld1 ... Ld6 = MAN 4640A
 (common cathode)

Miscellaneous:

S1 = double-pole change-over switch
 S2 = single-pole change-over switch
 S3 = DPST switch
 S4, S5 = spring-loaded push-button press-to-make switch
 X1 = 1 MHz or 10 MHz crystal (HC18 or HC25 holder) (see text)
 Tr1 = mains transformer, secondary 9 V/500 mA
 F1 = fuse, 100 mA, delayed action
 printed circuit 84462 (frequency meter less display)
 printed circuit 80089-2 (for the display)

10

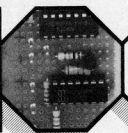

voltage-controlled audio switch

31

inverting input via ES2. The voltage division, and therefore also the output voltage, will therefore be zero. The clever part of this design is that ES1 is connected in series with A1 so it is part of the section that decides the amplification. The non-linear behaviour that could otherwise cause distortion of the signal is then to a large extent compensated by the feedback so that even hi-fi signals are not adversely affected. For this sort of application it is also a good idea to use a low-noise op-amp.

switches sounds electronically

In a few situations it is desirable to be able to switch audio signals electronically. One such situation is the muting circuit in FM receivers that substitutes silence for annoying noise when there is a very weak, or no, carrier signal present. This is the sort of switching function that electronic switch ICs, such as the 4016 or 4066, reveal in.

The circuit shown here works on a symmetrical ± 7.5 V supply but the IC containing the switches simply has $+15$ V. This set-up allows the circuit to work with pure a.c. signals. The operation of the circuit is quite straightforward. If the control input (x) is at $+7.5$ V ES1 will be closed and ES2 open. The effect is then that of an inverting unity gain amplifier. If, on the other hand, x is at -7.5 V ES1 opens and ES2

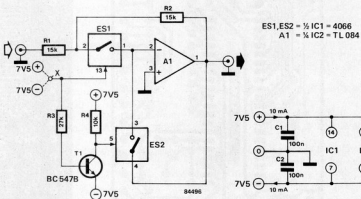

closes. The circuit then acts as a voltage divider, one side of which is made up of R1 and R2 in series and the other side is the very low output impedance of the op-amp. This output impedance is so low ($R_G / (1 + A_G)$) because the output is simply fed back straight to the

Apart from the TL084 shown in the circuit diagram, some possible substitutes are TL074 (low-noise!), LF356, or RC4136. A single 4066 contains four electronic switches so the circuit can easily be doubled to switch two channels, for stereo, for example.

10

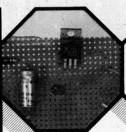

NiCad charger

32

The whole unit (voltage regulator and load) can then be connected in series with a (variable) load, in this case the nickel cadmium battery that is to be charged, and the current will still remain constant. This is, of course, always pre-supposing that the input voltage is high enough. The circuit has on subtle 'extra', in the form of a LED in series with the ground pin of the IC to indicate charging. A fixed current of 8 mA ± 1 mA, which is dependent on the output current selected and which must be added to this output current, flows through the LED. When the value of R1 is being decided the extra 1.5 V dropped across the LED must be taken into account. As we have already said, we decided to use this current source as a charger for NiCad batteries. Unlike lead-acid batteries these have to be charged at a constant current. Standard NiCads should be charged at a current which is 1/10 of the nominal capacity for 14 hours. Batteries that are not completely discharged do not need this long. In general the batteries will not be damaged by charging them for more than the rec-

based on a current source

The 78XX/79XX series voltage regulators have become so typecast in their main application that we tend to forget that they can also be used as current sources. This sort of current source can be very useful in many applications, such as charging NiCad cells, as in the circuit here. We will start by taking a look at the principle of the circuit, which, as the diagram shows, is very simple. The circuit is based on a voltage regulator with a constant load between the two points across which

the fixed voltage is found. The result is obvious: voltage and load are both fixed so unless Mr. Ohm got it very wrong the current is also constant.

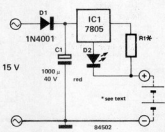

ommended time. It is advisable to discharge NiCads completely from time to time and then charge them again immediately as this can help make them operate at maximum efficiency for as long as possible.

The table shown here indicates several different types of batteries complete with the recommended charging current and the value that should be used for R1. The charging current can be made more exact by using a number of resistors in series to get the correct resistance. The values given here are the nearest standard values. If the charging current is more than about 150 mA the

Table 1.

	battery capacity (Ah)	charging current (mA)	R1 (Ω)	actual charging current (mA)
type AA (HP7)	0.5	50	120 ($\frac{1}{2}$ W)	54
type C (HP11)	1.8	180	39 (3W)	150
type D (HP2)	4.0	400	18 (5W)	330
PP3	0.11	11	560 ($\frac{1}{2}$ W)	12

$$I_c = \frac{6.5 V}{R1}$$

half-wave rectification provided by D1 should be changed to full-wave rectification by substituting a rectifier here. The job of the smoothing capacitor, C1, is thereby also eased. The maximum number of cells that can be charged at a time depends on the transformer voltage. At 15 V this is four (depending also on the quality

of the transformer and the values of charging current and smoothing capacitor), at 24 V ten cells can be charged. The output current from the transformer must be $\frac{1}{2}$ times the charging current.

M.S. Dhingra

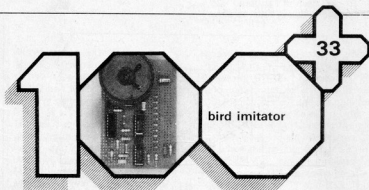

exotic, perhaps, but not esoteric

Perhaps it is a longing for nature in our technological society that prompts so many readers' requests for 'electronic birds'. And who are we to disappoint them? Since our knowledge of ornithology is rather restricted we would not like to say on which bird the present circuit is modelled, but it sounds exotic! The circuit consists of three relaxation oscillators and a decade counter. The oscillators are astable multivibrators, AMV1 . . . 3, each of which is based on two inverters. Oscillator AMV1 operates at a frequency of a fraction of a hertz, which is used to clock counter IC2. As long as the counter is triggered, a logic 1 travels across outputs Q0 . . . Q9 in rhythm with the clock. Oscillator AMV2 may be compared with the throat of a bird: it generates an audible high-frequency tone. Oscillator AMV3 provides a range of frequencies with which the output of AMV2 is modulated, so that the final output sounds like a bird and not like the time signal on the radio. The output frequency of AMV3 depends on the value of resistance between capacitor C4 and resistor R4, in other words on which of the resistors R8 . . . R11 is switched into circuit. The switching of these resistors is effected by CMOS switches ES1 . . . ES4, which are controlled by various combinations of counter out-

layout. It is, however, important that all outputs of IC2 are connected to the switches. If more than one output is connected to a switch, suitable diodes should be connected in series as shown to prevent short-circuits. Apart from the trigger pulses for the counter, AMV1 also generates pause pulses for AMV2. When the output of N1 (pin 4) is high, a current flows to pin 9 of N3 via diode D1 and resistor R1. This causes AMV2 to cease oscillating and the bird is quiet

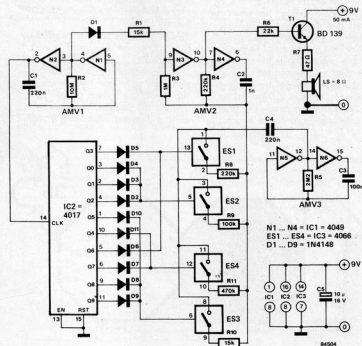

puts. This arrangement ensures that the final output is not a monotonously repeating sound, but is full of rich variations. Note that you may change the value of resistors R8 . . . R11 as well as the combinations of counter outputs and the connections to ES1 . . . ES4: our circuit shows only one possible

for a little while. A PP3 battery (9 V) is perfectly suitable as power supply. Finally, note that a small resonant loudspeaker can produce quite a volume of sound!

P. Ruopp

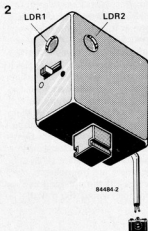
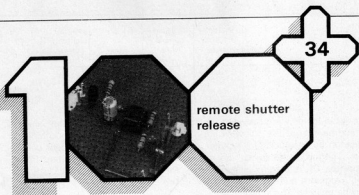

by opto-electronics

It is true, of course, that it has been possible for many years to release a camera shutter remotely. But that is normally done by a (too) short cable, which can be a nuisance, and which is invariably too expensive for what it does. It seems therefore a good idea to release the shutter optically: the only prerequisite for this is that the camera is provided with an electronic shutter-release facility.

The proposed circuit (see figure 1) is built into a small case (see figure 2) which is fitted with a flash connector enabling it to be fixed to the camera instead of the flash unit. The little case may be made from the screening can of an r.f. or i.f. transformer. The simple circuit is based on a type CA 3140 opamp which has been connected as a differentiator. To drive transistor T1, the inverting input of the CA 3140 must be fed with a short negative pulse. This is here obtained from quick changes in the light incidence onto either of the light-dependent resistors (LDRs), R1 and R2. Two LDRs are needed to provide the difference potential to which the

IC reacts.

It does not matter whether this difference is caused by a shadow falling onto R1 or a flash of light onto R2. The CA 3140 does not react to slow

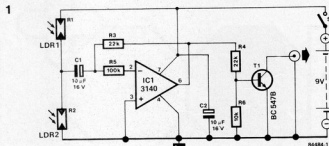

changes in incident light because of C1. Ambient light, which falls equally and simultaneously onto both LDRs, has no effect.

The negative pulses are inverted by the opamp and then used to switch on transistor T1 for an instant. The consequent short burst of current is sufficient to release the camera shutter. If you use a flash of light to operate the camera, you may be quite a distance away from it, par-

ticularly in the dark.

The circuit may be matched to a variety of cameras. The onset of conduction of T1 is dependent on the value of R4, while the sensitivity of the circuit may be augmented by increasing the value of R3. Current consumption depends on ambient brightness and lies between 1.5 and 5 mA.

P. Becker

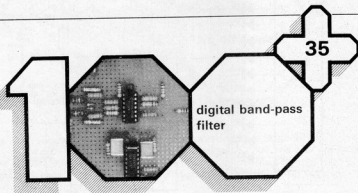

for alarm extension

The 'alarm extension' described in the October 1983 issue of *Elektor*, when used with a telephone cannot make a clear distinction between the call tone and the dialling tone. If this distinction is important, you may find the present filter circuit of interest. The circuit consists basically of ac-

tive filter stages A2 . . . A4, trigger stages A5 . . . A7, and digital filter stages MMV1 and MMV2. The level at the output of the circuit is CMOS compatible and is logic 1 when a call signal has been detected by L4. The output signal may be connected direct to the transmitter (pin 4 of IC1 in figure 2, page 10-53, *Elektor* October 1983). The supply voltage,

U_b , is halved by A1 and the operating voltage for the circuit is then taken from across C12.

The signal provided by pick-up coil L4 is rich in harmonics: after amplification in A2 it is applied to active low-pass filters A3 and A4 which remove virtually all harmonics. The cut-off frequency of A3 is 10 Hz and that of A4 is 25 Hz. The output of A4 is then either the 25 Hz (sinusoidal) call tone or the dialling pulses (= 10 pulses) whose rate is 10 Hz or below. When for instance '0' is dialled, the dial takes 1 second to return to rest. These frequencies can be clearly identified by the following stages.

When the output signal of A4 reaches its positive peak, a positive pulse is generated by A5; when it reaches its negative peak, a negative pulse is generated by A6. Operational amplifier A7 then gives an unambiguous control signal to IC3, the

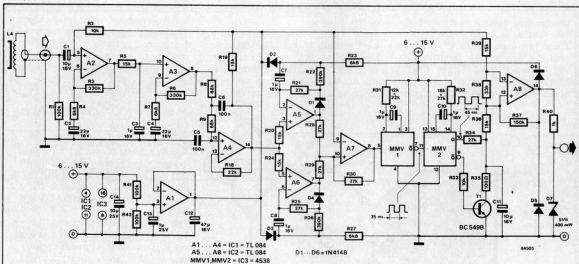

digital band-pass filter.

The digital band-pass filter consists of two retriggerable monostables, MMV1 and MMV2. When the period of the trigger pulse at the input of MMV1 is shorter than 35 ms, output Q (pin 7) remains logic 0. Only when the trigger period becomes longer, that is, when the frequency becomes lower than 28 Hz, does MMV1 generate a trigger pulse for MMV2. As long as the period of that

trigger pulse remains shorter than 45 ms, output Q (pin 10) is high. Capacitor C11 then charges over R34, and comparator A8 toggles: its output, which is the control signal for the transmitter in the alarm extension, is then logic 1. When the trigger period is longer than 45 ms, that is, when the frequency is lower than 22 Hz, MMV2 generates pulses which cause C11 to discharge at a constant rate via T1 and R35. The

level at the non-inverting input of A8 then drops below the threshold of the comparator. The output of the circuit is then logic 0 and the alarm extension is not actuated. During tests the circuit proved reliable, noise free, and this, coupled with a bandwidth of 6 Hz, makes it worth the trouble to build.

T. Schaerer

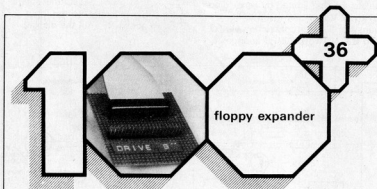

use 8" drives with a 5 1/4" interface

Someone once said 'Small is beautiful' and we wholeheartedly agree with him. In the case of this circuit, 'small' refers to the number of components it uses. It shows that two connectors (one 50-way and one 34-way) and a length of 50-way ribbon cable is all that is needed to connect an eight inch floppy disk drive to an interface intended for a five and a quarter inch diskette. What we are actually doing here is making the computer 'think' that the 8" drive is in fact a 5 1/4" unit. In order to achieve this two things are needed. First a cable must be made to link the 8" drive's 50-way connector to the 34-way one on the floppy disk interface. Note in passing that

all the 'uneven' lines are grounded in order to protect against cross-talk. The second 'difficulty' with connecting the 8" drive is that it has four lines which the 5 1/4" unit does not. This is not strictly true, but in the smaller drive they are combined with other signals. The 'ready' is combined with 'index', and 'head-load' with 'select'. 'Low current', on the other hand, which is only used on the 8" drive, limits the magnetising current when the inner tracks are being written. 'Side select' is, of

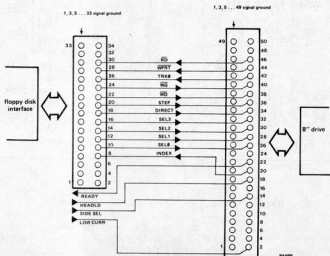

course, only needed when there are two read/write heads in the drive. These four lines can be left unconnected if they are first hardwired within the disk drive. The 8" drive can then be considered as a 5" one except that it has 80 tracks instead

of the usual 40. There is one modification needed to the hardware of the floppy disk interface to allow this circuit to operate at its best. The clock frequency of the ACIA on the interface card, which takes care of the parallel to

serial conversion, must be doubled. The reason for this is that the 8" floppy rotates faster than a 5" diskette so one and a half times as much information can be written on any track.

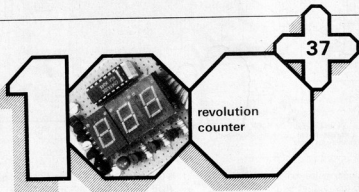

with digital read-out

The circuit presented is not only a suitable replacement of an existing mechanical rev counter, but may also be fitted in cars that have not one. The counting and memorizing occur in IC2, which also arranges the multiplexing of the signals to the three-segment display. Suitable units of time are arranged by oscillator N3 whose frequency is set to 1/3 Hz by P1. NAND schmitt trigger N2 generates a short negative pulse at the leading edge of the oscillator

pulses, that is once every three seconds. The content of the counter is then stored in the on-chip memory from where it will be provided to the display. Network C3/R7/D4 resets the counter at the leading edge of each LE pulse: a new counting cycle then starts.

The number of revolutions is derived from the pulses generated by the contact breaker in the car. These pulses are first limited by zener diode D1 to 12 V and then used to set transistor T1 into conduction via D2 and R2. Network C2/R6 arranges a

logic low at one of the inputs of NAND schmitt trigger N1 for a brief moment: the output of N1 is then 1 and this clocks IC2 so that the counter content is increased. The clock input is decoupled by D3 and R4.

The display is controlled via T2...T11 and IC3, which arranges the BCD-to-seven-segment conversion (BCD is binary coded decimal). Transistors T2...T4 pass the multiplexed signals to the display, while the remainder of the transistors are simply buffers. Resistors R13...R19 limit the current in the display.

The car battery voltage is reduced to 8 V by regulator IC4 and this then serves as the power supply for the rev counter. Current consumption amounts to about 150 mA.

The rev counter may be calibrated with the aid of the mains frequency. Connect an alternating voltage of 6...15 V (for instance, from the secondary of a bell transformer) via a single diode (polarity!) to the input (R1) and adjust P1 until the display

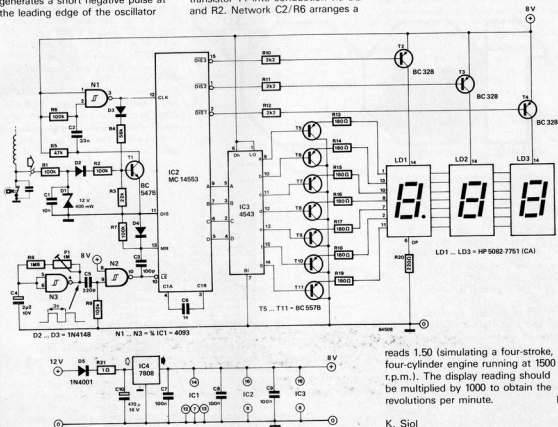

reads 1.50 (simulating a four-stroke, four-cylinder engine running at 1500 r.p.m.). The display reading should be multiplied by 1000 to obtain the revolutions per minute.

K. Siol

38

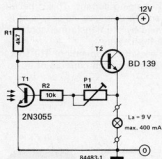
2N3055
sunswitch

a power-photo transistor

The 2N3055, strange though it may seem, can operate very well as a photo transistor, as the circuit here shows. The power transistor must be made light sensitive, of course, and this is done by cutting off the top of the case. The light-sensitive area revealed is quite large enabling the

'new' photo transistor to operate very effectively.

The sunswitch is based on two transistors, the decapitated 2N3055 (T1) and a switching transistor, T2. As long as no light (or not enough) falls on T1 this transistor does not conduct. Resistor R1 then provides a base current for T2, which conducts and lights the lamp at the output of

the circuit.

When enough light falls on T1 it conducts and earths the base of T2 so the lamp extinguishes. The two transistors are coupled via R2 and P1 to improve the switching behaviour. The light intensity at which the circuit switches is set by means of preset P1.

from an idea by H.J. Hooff

39

self-switching
battery charger

the gate current to Th1 to drop below the holding value. When that happens, Th1 cuts off and switches the charging current to the battery off: the ammeter then reads 0. When after some time the battery voltage drops below its nominal value again, the gate current to Th2 drops. SCR Th2 then cuts off, the gate current to Th1 increases, that SCR conducts, and a charging current flows again to the battery.

The charger is calibrated by connecting a fully-charged battery in the circuit and adjusting P1 so that just no

for hibernating batteries

This is a charger designed specially for batteries that are not used for long periods, e.g. those of motorcycles that are laid up for the winter. You then take the battery from the vehicle and connect it permanently to the charger, which is switched on one or two times during a week. The battery is charged and when it has reached nominal voltage, the charger switches itself off. It remains on standby, however, and when the battery voltage has dropped below the nominal value, it switches itself on again.

Suppose that the battery in the circuit diagram has a voltage below its nominal value. As soon as the charger is switched on, a current flows through D3 to the gate of silicon-controlled rectifier (SCR) Th1. The SCR conducts and a charging current flows through the battery that is indicated by ammeter M. The battery voltage increases gradually and with it the potential across R1/P1. Capacitor C1 then charges and at a given level of voltage across

it, zener diode D4 starts to conduct. A current then flows to the gate of Th2: this SCR conducts and causes

current flows through the ammeter. Note that the transformer must not be called upon to deliver more than

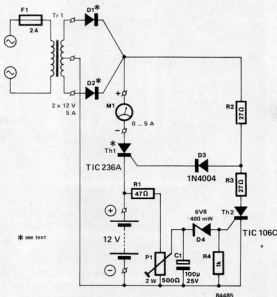

5 A charging current. This is because when Th1 conducts its only load is formed by the transformer secondary and the battery. For security of operation, Th1 should be able to switch currents of up to

10 A: the TIC 236A and TIC 246A, for instance, meet this requirement. The same applies to the silicon rectifier diodes for which the SKN26/04, SD25, BYS24-90, for instance, are suitable. The maximum

forward current of these diodes should not be below 8 A!

*General Electric, Auburn, N.Y., U.S.A.
Notice 630.15*

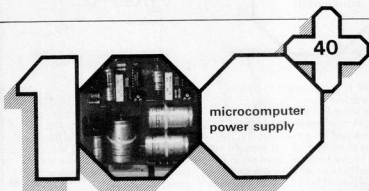

provides $1 \times 5 \text{ V}$ and $3 \times 12 \text{ V}$

The attraction of this power supply is based on two of its characteristics. First of all it is extremely compact and secondly it supplies three, or strictly speaking four, voltages: $+5 \text{ V}/3 \text{ A}$, $+12 \text{ V}/2 \text{ A}$, and a symmetrical $\pm 12 \text{ V}/250 \text{ mA}$. The credit for the compactness is due to the fact that only one transformer is used for the three voltages. It is a toroidal transformer made by ILP (they call it a 4T344) and has three secondary windings of $9 \text{ V}/7.2 \text{ A}$, $15 \text{ V}/3.2 \text{ A}$, and $15 \text{ V}/0.5 \text{ A}$. It could,

of course, be replaced by three separate transformers but then the circuit would lose a lot of its charm. We felt no need to re-invent the wheel as regards the voltage regulating circuitry. A pair of 723s followed by TIP 142s to do the heavy work are used for the 5 V and 12 V . The symmetrical $\pm 12 \text{ V}$ is provided via a 7812 and a 7912 (IC3 and IC4). Thanks to the printed circuit board of figure 2, building this power supply is very straightforward. It is important to mount transistors T1 and T2 on a heatsink. This should have a temperature rise of a maximum of

$1.5^\circ\text{C}/\text{W}$ and can be common to both transistors. Each of the transistors must, of course, be fitted with a mica washer between it and the heat sink. Voltage regulators IC3 and IC4 must each be provided with a heatsink of $15^\circ\text{C}/\text{W}$.

The noise suppression in this power supply proved very good when we tested the prototypes. At full load there was barely a ripple to be seen on the oscilloscope even when it was set to 10 mV per division. The stability was also shown to be excellent. Switching from full load to no load gave a voltage difference of only a few millivolts.

Two final remarks. As we have already said, the toroidal transformer can be replaced by three separate ones. In this case the minimum needed is one $9 \text{ V}/5 \text{ A}$ transformer, one $15 \text{ V}/3.2 \text{ A}$, and one $15 \text{ V}/0.4 \text{ A}$. If you wish to protect this supply against overvoltages and short-circuits this can easily be done by adding the 'microcomputer power supply protection' circuit described elsewhere in this issue.

2

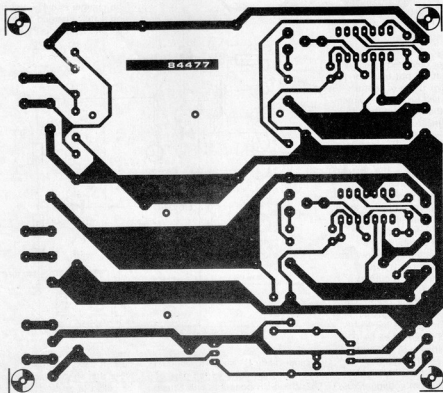

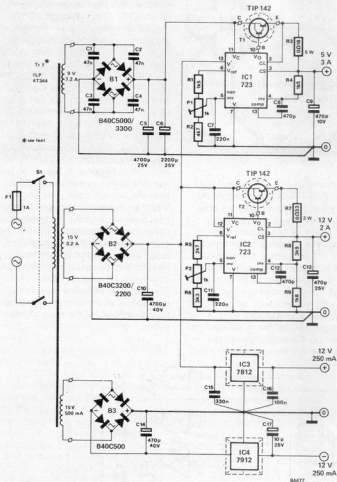

Parts list

Resistors:

R1, R4 = 1k5
 R2 = 4k7
 R3 = 0R18/5 W
 R5 = 2k7
 R6 = 3k3
 R7 = 0R33/2 W
 R8 = 3k9
 R9 = 1k8
 P1, P2 = 1 k preset

Capacitors:

C1...C4 = 47 n
 C5 = 4700 μ /25 V
 C6 = 2200 μ /25 V
 C7, C11 = 220 n
 C8, C12 = 470 p
 C9 = 470 μ /10 V
 C10 = 4700 μ /40 V
 C13 = 470 μ /25 V
 C14 = 470 μ /40 V
 C15 = 330 n
 C16 = 100 n
 C17 = 10 μ /25 V

Semiconductors:

B1 = bridge rectifier, 5 A/40 V,
 e.g. B40C5000/3300
 B2 = bridge rectifier, 3.2 A/40 V,
 e.g. B40C3200/2200
 B3 = bridge rectifier, 500 mA/40 V,
 e.g. B40C500
 T1, T2 = TIP 142
 IC1, IC2 = LM 723
 IC3 = 7812
 IC4 = 7912

Miscellaneous:

F1 = fuse, 1 A slow blow
 Tr1 = toroidal transformer, ILP no. 4T344
 Heatsink for T1 + T2, max. 1.5°C/W
 2 off heatsink for IC3 and IC4,
 max. 15°C/W
 S1 = double pole mains switch

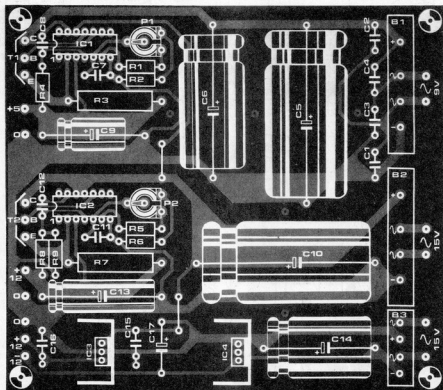

single-button code lock

to thwart would-be housebreakers

The disadvantage of almost every available code lock is that some sort of keyboard must be mounted at the door for keying in the (secret) code to open the lock. These keyboards attract attention with the result that all sorts of undesirables are likely to be found tapping on the buttons. The circuit here uses the normal doorbell push button to feed in the secret code. The code consists of a series of long and short pulses, just like a sort of Morse. At the centre of the circuit is an eight-bit shift register (IC1). The outputs of this IC are connected, via switches S1 . . . S8, inverters N3 . . . N10,

and diodes D1 . . . D8, to the base of transistor T1 which controls the lock relay. This transistor can only conduct if there is a '1' on the cathodes of all the diodes. In all other cases the base current supplied by R3 will be 'carried away' by one or more diodes. The switches are used to select 'normal' or inverted output from the register. This is how to set the secret code, which in the diagram here is 00110011.

When the bell button is pressed Rel closes and the bell rings. At the same time the second relay contact

switches the flip-flop consisting of N1 and N2. The output of N2 provides the clock signal to IC1 and N1 triggers monostable multivibrators MMV1 and MMV2. The data that is read into the shift register is produced by MMV1 but it is only shifted after N2 supplies a rising clock pulse, which happens when the bell push button is released. The monostable time of MMV1 is short: about a half second. If the button is released within this time a '0' is read in, any longer time produces a '1' as Q of MMV1 has become '1' again. In this way the shift register can be filled with the correct code. The second MMV serves as a protection by resetting the shift register if no pulses come for five seconds. The lock then closes again (or remains closed). The pulse times and the reset time can be changed by modifying the values of R5 and R4 respectively. The circuit is powered via a 5 V regulator and the current consumption is defined by the type of relay used.

T.G. Tio

1a

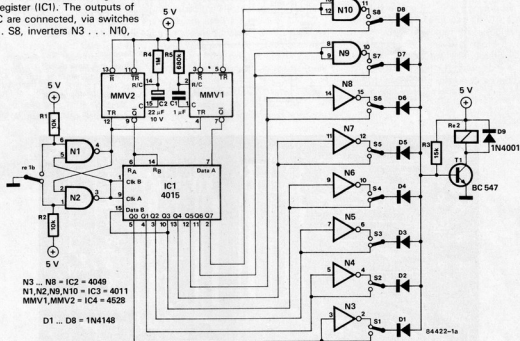

1b

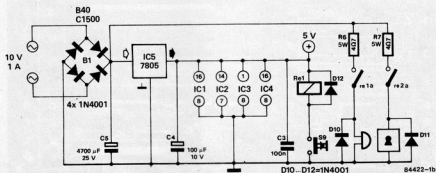

dissipation limiter

the load current, I_L . When U_{C1} drops below the level of $U_O + U_Z$, T1 and Th1 conduct again so that C1 is charged afresh. And so the process continues . . .

The moment T1 and Th1 are turned on, the current through C1 suddenly increases (see figure 2) and drops back to nominal when these devices are cut off. The current surges through C1 (or, if you prefer, the switching on of T1 and Th1) occur every half-cycle, or every fourth half-cycle, or whenever, of the pulsating

for variable power supplies

Most mains power supplies nowadays make use of a voltage regulator IC. These circuits undoubtedly simplify the design and result in a more compact unit. This applies to fixed output as well as to variable output devices. The latter have, however, one unfortunate characteristic: at high input voltage, low output voltage, and low load current, the dissipation in the regulator is maximum.

This loss can be minimized with little additional effort and cost as can be seen from the circuit diagram. In this, the additional components are connected between the bridge rectifier and capacitor C1.

Immediately after switch-on, a zener voltage, U_Z , develops across D5 which causes T1 to conduct. The current through T1 then flows to the gate of silicon-controlled rectifier (SCR) Th1. The SCR then conducts and the consequent current charges C1 via R4. It is only when C1 is charged that the regulator, IC1, provides an output voltage, U_O , whose level is preset with P1.

What happens next becomes clearer from figure 2. Once C1 has been charged to its maximum voltage, U_{C1} , the current through Th1 drops

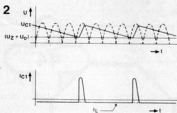
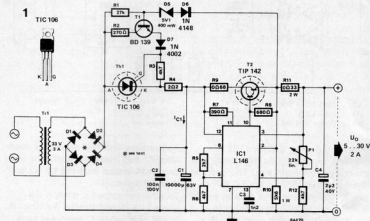

below the holding value and the SCR blocks. Power to the load is now supplied only by C1 which naturally discharges. The rate of the discharge depends on the value of

direct voltage (shown in dotted lines in figure 2) at the junction D2-D4. The time when they occur is dependent only on the value of the load. Because of the surges, diodes D1 . . . D4 should be 10 A types, e.g. SKN 26/04.

The input voltage to the regulator IC must not exceed 80 V; the output voltage may then be preset between 5 V and 50 V. Obviously, the transformer, D1 . . . D4, and C1 must be rated to cope with these values. ■

SGS, Technical Note 145

electronic key-set

U_b (V)	I_b (mA)
3	0.45
5	2.8
9	10.2
15	23.5

to close at the same time, which can have disastrous consequences.

The circuit is simplicity itself: five standard or miniature push-button switches, two ICs, four resistors, six diodes, and five LEDs. The heart of the circuit is IC2, a BCD-to-decimal decoder type 4028. This guarantees that whatever the input information only one of its outputs is logic high (= switch closed).

To start at the beginning: inputs A . . . D of IC2 are at low logic level via resistors R3 . . . R6 and the 0 output is therefore logic 1. This is inverted by N1 which causes D1 to

prevents multiple entries

This electronic key-set, although similar to its mechanical counterpart (switching, interlocking, reciprocal release, and so on) has one import-

ant advantage over it: when two or more keys are pressed simultaneously, all contacts remain open, which is by no means guaranteed with a mechanical set. The latter may actually allow several contacts

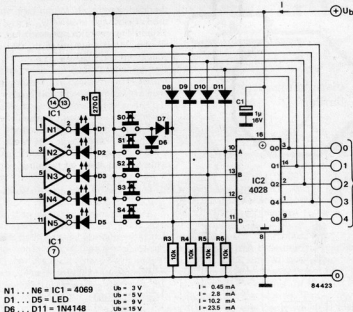

N1 ... N6 = IC1 = 4069
 D1 ... D5 = LED
 D6 ... D11 = 1N4148

U_b = 3 V
 U_b = 5 V
 U_b = 9 V
 U_b = 15 V

I = 0.45 mA
 I = 2.8 mA
 I = 10.2 mA
 I = 23.5 mA

84423

light. If then, for instance, S1 is pressed, input A goes high while the other inputs remain low. The decoder then switches from output 0 to output 1. The high level output at pin 14 is fed back (interlocked) to input A via diode D11 so that a stable situa-

tion ensues and this continues even after S1 has been released. The level on pin 14 is also inverted by N2 so that D2 lights. To activate output 3, switch S3 should be closed briefly. As input A is still high when C becomes high,

the input information to the decoder is briefly 0101 (decimal 5), and IC2 therefore activates output 5 which has not been connected. As output 1 then goes low, the feedback to input A disappears and pin 10 becomes logic 0. Only input C is then high and IC2 switches on output 3. The interlock now lies across D9 to input C. Simultaneously, the level on pin 1 is inverted by N4 which causes D4 to light. The operation is similar when the other push buttons are pressed.

Because only decimal outputs Q0 ... Q4 and Q8 of IC2 are terminated, only the corresponding binary inputs can change the state of IC2. This is, however, only so if only one switch is pressed. When more are operated simultaneously, IC2 receives input information that activates non-terminated decimal outputs. The terminated outputs are logic low as long as the switches are pressed, and all LEDs remain off. Switch S0 activates output 0: the input information to IC2 is then 1001 (decimal 9) As the corresponding output is not terminated, there is no interlock to the input, so that inputs A ... D go low as soon as S0 is released.
 H.J. Probst

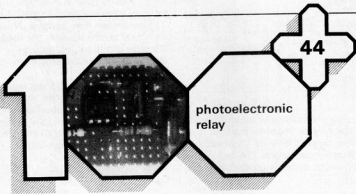

switches up to 1750 VA

Motorola ICs 3040 and 3041 enable the construction of a simple electronic relay that in spite of its simplicity has some interesting characteristics. For instance, the ICs

have an internal zero crossing detector that saves quite a few external components. Moreover, the ICs have an isolation voltage of not less than 7.5 kV which enables the relay to be connected to any circuit operating from mains voltage.

The ICs may be compared with a normal opto-coupler in which the usual phototransistor has been replaced by a phototriac (100 mA/400 V at 25°C). The advantage of this is that virtually all types of silicon-controlled rectifiers (SCRs) may be used in the circuit, which would not be possible if a phototransistor were used.

The choice of type of SCR depends on what is to be switched by the relay. If the load is resistive, a TIC 226D/400 V will do fine. If, however, inductive loads have to be switched, a 600 V SCR, for instance, a type TIC 226M, is needed. Bear in mind that the operating voltage of capacitor C1 must correspond to the type of SCR used.

The value of R1 depends on the input voltage, U_{in}, and is calculated from
 $R1 = 1000 (U_{in} - 1.3) / I_{OC}$
 where U_{in} is in volts, R1 is in ohms, and I_{OC} the current through the LED in the opto-coupler, is in mA. Assuming U_{in} = 12 V, and I_{OC} = 30 mA (as in the MOC 3040), the calculated value of R1 = 356 Ω for which a standard 330 Ω should be used. In the MOC 3041 I_{OC} is only 15 mA, so that the practical value of R1 would be 680 Ω. The maximum current that the electronic relay can switch is about 8 A.

Motorola application

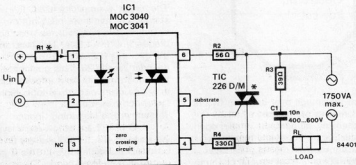

45

one-armed bandit . . .

his or her luck. If D6 does not extinguish (because Q6 and Q7 are not high) the same player has another go.

The player who has amassed the largest number of points at the end of the game is the winner or the loser, depending on how you play this game of chance.

The circuit needs a power supply of 4.5 . . . 9 V. The current consumption is dependent mainly on the bias resistors R3 . . . R7: with values shown, the current through each of

. . . uses LEDs

We present a new game that might be described as a sort of electronic one-armed bandit. The good news is, however, that you don't have to put money into it; the bad news is that you cannot win money from it either. So, for the stakes, you'll have to come to an agreement with your playing partners.

The circuit is based on a type 4024 seven-stage binary counter/divider. At the beginning of the game it is reset by spring-loaded push-to-make switch S2. The counter outputs, Q1 . . . Q7, are then logic low, and the LEDs, D1 . . . D5, are out. The output of NAND Schmitt trigger N2 is high and switches on relaxation oscillator N3. The oscillator signal is inverted in N4 and this turns on amplifier T6 so that LED D6 lights. The game is started by pressing another spring-loaded push-to-make switch, S1, when oscillator N1 is turned on and clocks the counter. As soon as S1 is released, N1 ceases to oscillate and the counter stops at a random output combination. One or more of the LEDs D1 . . . D5 will be alight at that time and each of these is awarded a point or points as you

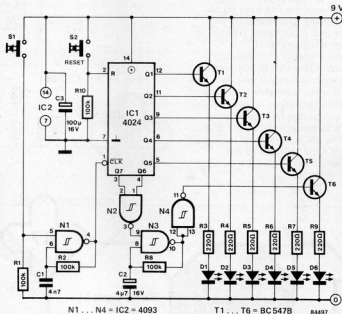

N1 . . . N4 = IC2 = 4093

T1 . . . T6 = BC547B 84497

may decide. Note the number of points before S1 is pressed anew. When outputs Q6 and Q7 of the counter are both high, N3 ceases to oscillate and LED D6 goes out. This is the signal for the next player to try

the LEDs is about 30 mA. The size and colour of LEDs D1 . . . D5 may be chosen to your own preference.

H.J. Walter

46

stereo doorbell

audio interrupter

The stereo is on, playing loud enough to do justice to your favourite rock record. The doorbell rings but in your ecstasy you don't realize it, even if you had been able to hear it. It doesn't take long before

the would-be guest gets fed up and decides to protect his (or her) gentle ears by going someplace quieter, like a heavy metal concert. That leaves you with two options: cut the mains lead of the stereo or fit a more effective doorbell.

The circuit here is a combination of

the two but we guarantee it is less destructive than the first. It cuts the volume of the stereo's output drastically when the bell is operated. Then to make sure the message is received the bell gives a number of tones of different frequencies switching from one channel to the other. The operation of the circuit is quite simple. When the bell button is pressed there is a voltage across the bell which is rectified by diode D1 to provide a logic '1'. This causes a number of things to happen, the first of which is that electronic switches ES1 and ES2 are closed. The outputs of both left and right channels are then greatly attenuated. At the same time the rhythm generator based on N1 starts working. This controls oscillators N3 and N4 and ensures that the signals they provide are fed to the left and right channel respect-

ively. The tone in the left channel is at about 800 Hz while that in the right channel has a frequency of about 400 Hz.

The current drawn by this circuit is quite small, at less than 5 mA. The supply voltage could be provided by a battery or it could be taken from the bell transformer. Note that the signal earth is taken from the centre of voltage divider R4/R5.

The volumes of the bell tones are set by means of presets P1 and P2. Be very cautious about setting the volume too high as the rectangular waveforms of the bell tone signals contain many high-frequency harmonics that could cause tweeters to become terminally dead.

The circuit should be connected in the audio system preferably between preamplifier and power amplifier. This point is often accessible by means of a preamplifier output/power amplifier input connection. A second possibility is to connect the inputs of the circuit to the tape recorder outputs and the circuit outputs to the recorder inputs. Then set the amplifier to tape playing.

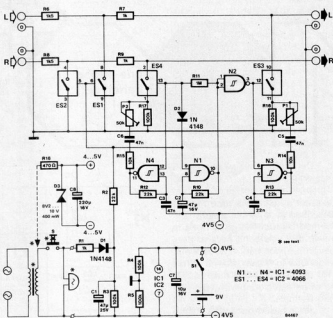

N1... N4 = IC1 - 4093
ES1... ES4 = IC2 - 4066

8487

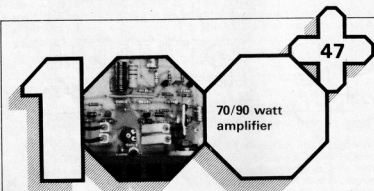

subject to temperature fluctuations by mounting T7 on the same heat sink as T6 and T9. This current is actually set by trimming R16. The amplifier's a.c. stability is improved by the inclusion of RC networks in the output stage and in the feedback loop. If it is considered necessary, overload and short-circuit protection is provided by the circuit shown in figure 2. This should be mounted in the space indicated by the dotted lines in figure 1.

The amplifier is designed to provide a power of 70 W into 8 Ω, but if the component values given in brackets are used it can be connected to 4 Ω

a class AB design for
4 Ω or 8 Ω loads

This is an amplifier with a very simple layout that none the less produces quite a high power. Power isn't everything, however, (no matter what some politicians think) so it is backed up in this case by the other specifications, which are quite good. A symmetrical supply was chosen in order to avoid the problem of having to use an electrolytic capacitor at the output. Consequently a differential amplifier is used at the input. The input signal is fed to the base of transistor T1 and feedback is taken from the base of T2. The current through the differential stage is kept at a constant 1 mA by the action of current source T3. The amplified input signal is taken from the collector of T1 to darlington T4/T8, which, in combination with current source T5, forms the class A driver stage for the power transistors. The current through the driver stage is quite small (about 7 mA) because T6 and

T9 are power darlington.
The class AB quiescent current for the power transistors is made less

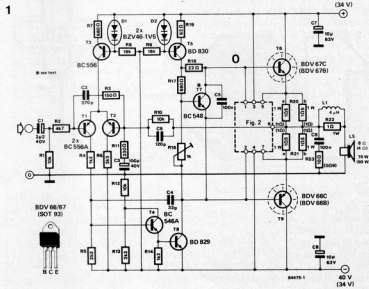

8487.1

loudspeakers and then provides a maximum of about 90 W. The protection circuit of figure 2 must also be modified if a 4 Ω load is used. The values of R24 and R28 are then 3k9, R26 and R28 are 220 Ω, and D5, D6 and R30 are removed altogether.

The power supply (not indicated) need only consist of the usual transformer, rectifier and smoothing capacitors. The electrolytic capacitors should be about 5,000 to 10,000 μF each. The rectified voltage for the 70 W/8 Ω version should be ± 40 V with the load; with no load this corresponds to about ± 47 V. At 4 Ω these values are ± 34 and ± 40 V respectively. Don't underestimate the transformer requirements! It must be able to provide 1.4 A for the

2

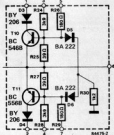

70 W/8 Ω version (mono) and 2.2 A for the 90 W/4 Ω version. It is strongly recommended that a fuse be included in both positive and negative supply lines; 2 A for 8 Ω or 3 A for 4 Ω. Finally, a word about the cooling requirements of T6 and T9. In the 8 Ω

Specifications:

output power (f = 1 kHz, d = 0.5%):
75 W into 8 Ω (97 W into 4 Ω)
offset voltage: < 40 mV
quiescent current (set with R16): 50 mA
input impedance: 10 kΩ
input sensitivity: 760 mV (600 mV for 4 Ω)
harmonic distortion
(at P_{max} and 1 kHz): 0.01%
intermodulation distortion
(at P_{max} and 1 kHz): 0.02%
frequency range
(-2 dB, reference level 10 dB under P_{max} at 1 kHz): 10 Hz . . . 60 kHz
signal to noise ratio (P = 50 mW)
- weighted A curve IEC 179: 83 dB
- unweighted curve: 75 dB

mono amplifier the heatsink for these transistors must be rated at 3.4°C/W maximum; for stereo this is 1°C/W. These values become 2.5 and 0.5°C/W for the 4 Ω version.

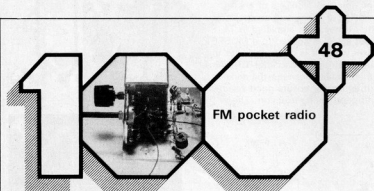

with just six transistors

To the best of our knowledge this is the simplest FM radio that can be made. Not only that but it also works quite well, even if the sensitivity does not seem very good. The principle of this receiver may appear somewhat unusual to some. It is based on a 'synchronizable oscillator' consisting of transistors T2 and T3 that is synchronized to the received frequency by means of T1. This transistor operates as a wide-band HF preamplifier for the FM band. In principle this amplification stage could be omitted and the aerial connected directly to capacitor C4, but the sensitivity would then be greatly reduced.

The oscillator is tuned by capacitor C5 to about 87 . . . 108 MHz and, because of the synchronization already mentioned, the frequency shows the same variations as the signal picked up by the aerial. These frequency variations, of course, represent the AF information.

The AF information is extracted by the simple expedient of considering the T2/T3 oscillator as an 'inverted transmitter'. If we wanted to use the oscillator as a transmitter then a small modulating voltage across P1/R5 would be enough to cause the

modulated voltage to be generated across P1/R5. This voltage represents the original information transmitted so after low-pass filtering (R6/C6) and amplification (T4 . . . T6) the demodulated AF signal is presented to the output of the circuit.

The winding details for the coils are indicated in the diagram. The radio is tuned to different stations by means of tuning capacitor C5. Potentiometer P1 should then be set to give the best possible reception of the transmitter. Combined with a

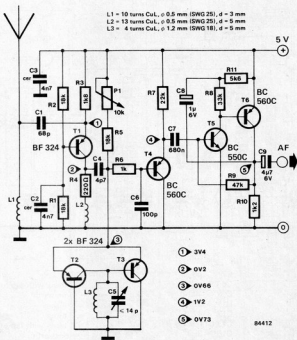

frequency modulation. The converse of this is that if the signal is already frequency modulated by some other means (the modulation in the transmitted signal) it will cause a

loudspeaker and amplifier this circuit can easily be made into a very compact pocket radio.

P. Engel

VHF/AM air band convertor

can also be used in the 2 m amateur band

Many enthusiasts would be interested in listening to what goes on in the v.h.f. air band of 108 . . . 132 MHz were it not that receivers covering those frequencies are fairly expensive. Fortunately, air communications use amplitude modulation and if you therefore have a good short-wave receiver it is pretty straightforward to connect a suitable converter to it. And that's what this article is all about . . . The converter actually covers the fre-

quency range of about 106 . . . 150 MHz so that apart from the air band it covers a small part of the broadcasting band (up to 108 MHz, but that's mainly f.m.) and the 144 . . . 146 MHz (that is, the 2 m) amateur band.

The converter consists of a v.h.f. amplifier, a mixer, and an oscillator. After it has been amplified in T1, the input signal is applied to a MOSFET mixer where it is combined with the output of crystal oscillator T3. Three tuned circuits between the aerial input and mixer ensure good selectivity and good image rejection. The

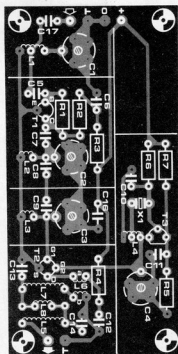
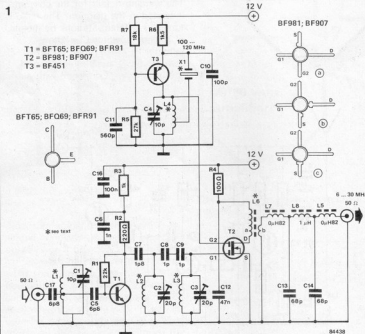
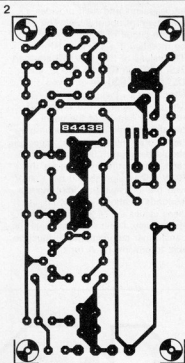

Parts list

Resistors:

R1 = 22 k
R2 = 220 Ω
R3 = 1 k
R4 = 100 Ω
R5 = 27 k
R6 = 1k5
R7 = 18 k

Capacitors:

C1, C4 = 10 p trimmer
C2, C3 = 20 p trimmer
C5, C17 = 6p8
C6 = 1 n ceramic

C7 = 1p8

C8, C9 = 1 p
C10 = 100 p
C11 = 560 p
C12 = 47 n
C13, C14 = 68 p
C15 = 3p3
C16 = 100 n

Semiconductors:

T1 = BFO69, BFR91, BFT65
T2 = BF907, BF981
T3 = BF451

Inductors:

L1 = 7 turns with tap at 3 turns }
from earth }
L2 = 3 turns }
L3 = 3 turns }
L4 = 4 turns with tap at 1 turn }
from earth }
L6a = 4 turns enamelled copper }
wire SWG 36 }
L6b = 4 turns enamelled copper }
wire SWG 24 }
L5, L7 = 0 μ H82
L8 = 1 μ H

enamelled copper
wire SWG 20
close wound on
pencil

together on ferrite
bead 3 \times 8 mm

Crystal 100 . . . 120MHz,
fifth overtone

available from
IQD Limited
North Street
Crewekerne
Somerset TA18 7AR

PC Board 8443B

difference-frequency output of the mixer is taken from its drain and fed to a 50 ohm output via a filter consisting of L7, L8, L5, C13, and C14. Tuning is carried out at the short-wave receiver between 6 and 30 MHz.

The bandwidth of the tuned circuits is, of course, not sufficient to cover the whole range of about 106 . . . 150 MHz. At around 106 MHz the bandwidth is some 3 MHz; at 150 MHz it is about 12 MHz. Once you have chosen the band you want to listen in, tune the

crystal and circuits L1-C1, L2-C2, and L3-C3 to the centre frequency of that band. The crystal frequency, f_x , is equal to the difference between the input frequency, f_i , and the output frequency, f_o : $f_x = f_i - f_o$, where f_o should be as high as permitted by the crystal frequency which should lie between 100 and 120 MHz. For instance, if you want to receive the 117 . . . 119 MHz band, f_x could be 100 MHz (to keep f_o as high as possible) and the short-wave receiver would be tuned between 17 and 19 MHz. If you select the 2 m

amateur band, the short-wave receiver could be tuned between 28 and 30 MHz so that the crystal frequency would be 116 MHz (144 . . . 146 - 16 = 28 . . . 30 MHz). Air coils L1 . . . L4 may be wound on a pencil and L6 on a ferrite bead, while L5, L7 and L8 are available ready made. Note that the printed circuit is double-sided so that the component side is an earth plane to which the various r.f. screens shown in figure 2 should be soldered.



composite and compact

It seems that we cannot publish too many mains power supply projects: the number of readers' requests for these exceeds that for any other topic. To satisfy many readers, here is a computer power supply which can be built in a small space, provided you use the toroidal transformer shown. You may, of course, use three single transformers where space allows.

In the positive supplies we have used type TEB or LM 0338 voltage regulators, the output of which may be fixed by two external resistors: R1/R3, R2/R4, and R8/R7 respectively. Resistors R1 and R2 may be replaced by a 270 ohm resistor in series with a 220 ohm preset so that fine control of the output voltage is available. The maximum output current of these regulators is 5 A: at this value internal current limiting comes into action. However, when both 5 V lines are used simultaneously, the maximum combined current must not exceed 6 A. This restriction does, of course, not apply when individual transformers are used. At the same time, bear in mind the maximum permissible current through the rectifiers. In the negative 12 V supply a type 7912 regulator is used which provides a maximum current of 1 A. All voltage regulators must be fitted onto suitable heat sinks. Capacitors C1 . . . C5, C7, C8, C13 . . . C17, C19, C23 . . . C26, and

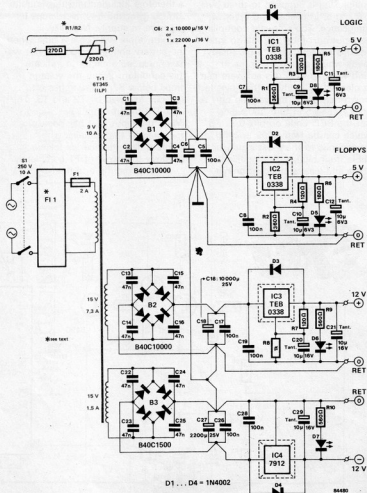

joystick interface

an inexpensive unidimensional design

Just as it is very easy to implement an 'all or nothing' control (four positions identified by two bits, or eight positions identified by three bits) it is very difficult to realise an inexpensive proportional control. When a reader suggested using an analog to digital converter, such as a 3162, to convert the voltage at the wiper of a joystick potentiometer into a single binary word we recognised the potential of the idea. The IC used is more than just a normal analog to digital converter as it provides a *multiplexed BCD output* (4 bits: pins 2, 1, 15 and 16). The information needed for multiplexing is supplied to three pins: 4, 3 and 5, in descending order of significance. The software controlling the input port must be able to interpret this information and the main points which should be borne in mind when writing this software can be gleaned by studying the flowchart shown here. A '0' appears on port A bits 7, 6 and 5 in turn, indicating that the BCD code on bits 0...3 (which can be from 0000 to 1001) corresponds to the most significant nibble (four bits), next significant nibble and least significant nibble

respectively. The position of the wiper of preset P2, which is part of the voltage divider connected to joystick potentiometer P1, determines whether the output values range from 0 to 255 (which can be transmitted as a single hexadecimal byte — FF_{HEX}) or from 0 to 999 (three BCD digits).

The power for the circuit could be provided either by the microcomputer to which the interface is connected, or by a voltage regulator fed a voltage of 8...15 V. The voltage reference applied to voltage divider R6/P2/R7 must, however, be very stable so it cannot come from the circuit's supply. A small 9 V battery is therefore included and this is quite sufficient for the few microamps it will have to supply. Naturally enough, there will come a time when the battery voltage is too low but we have included a circuit to indicate this condition. When the voltage drops below 8 V T1 switches off, speedily followed by T2 and T3. The LED, D1, then extinguishes.

When the input port has been programmed all that remains is to calibrate the interface, as follows:

- Move the wiper of P1 completely towards ground and then trim P3

to get an output of zero (000 or 001).

- Move the wiper of P1 as far as possible towards P2 and then trim this latter preset to get the maximum value (either 254 or 255, or 998 or 999).

The values set during calibration may be altered somewhat if necessary in order to prevent any possibility of the upper or lower limits being passed.

This is done by selecting, for example, 005 as the lower limit and 250 or 994 as the upper limit. Then there is little need to worry about the stability of the battery voltage.

P. Palisson

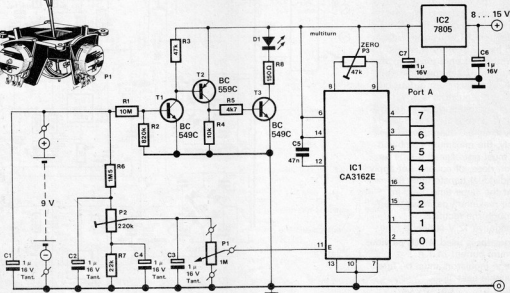
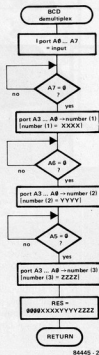

READERSHIP SURVEY

In electronics, negative feedback keeps a system stable. Positive feedback makes it oscillate.

In the same way, negative feedback from readers keeps the editorial staff from swinging too far out on a limb; positive feedback, quite honestly, is the spice of life.

Readers' letters are useful. Talks with 'the trade' help. But there's nothing to beat a 'Readership Survey'! you get straight answers to straight questions. There are no firm rules. Tick any box that seems appropriate (preferably not more than one per question, unless otherwise specified): add a postage stamp if you have one handy (no apologies: we are avid stamp collectors!) and send it in (the sooner the better, but there's no closing date).

We are looking forward to hearing from you!

Your editor

FIRST FOLD

THIRD FOLD

To:
elektor electronics pvt ltd.
3, chunam lane dr. d. bhadkankar marg, bombay-400 007.

SECOND FOLD

TUCK IN

Attach
Postage
Stamp
here

Contents of Elektor

1 In which of the following subjects are you really interested?

(More than one choice is possible)

- audio/hi-fi (1)
- electronic music (2)
- video (3)
- radio/h.f. (4)
- computers
 - construction (5)
 - interface, peripherals (6)
 - software (7)
- measuring equipment (8)
- domestic applications (9)
- vehicle applications (10)
- electronics for other hobby (model railways, photography, etc.) (11)

2 Which of the following do you find characteristic of the articles in Elektor?

(more than one choice is possible)

- readability (1)
- good background information (2)
- often too long (3)
- often too dry (4)
- often too witty, too chatty (5)
- often too short with insufficient details (6)
- clear construction details (7)
- practice oriented (8)
- easy to understand (9)
- often too theoretical (10)

Experience with projects

3 How many projects do you build each year?

- none (1)
- one (2)
- two (3)
- three to five (4)
- five to ten (5)
- more than ten (6)

4 What is your experience with component availability for Elektor circuits?

- no problem (1)
- usually fairly easy (2)
- often a problem (3)
- hopeless (4)

5 In your experience, do the projects

- usually work first time (1)
- work only after some trouble shooting (2)
- rarely work at all (3)

6 Do you usually

- build as described in Elektor (1)
- make a few modifications (2)
- make a large number of modifications (3)

Buying habits

7 How much do you spend per year on leisure electronics?

- less than Rs. 300 (1)
- Rs. 300 to Rs. 750 (2)
- Rs. 750 to Rs. 1500 (3)
- Rs. 1500 to Rs. 3000 (4)
- more than Rs. 3000 (5)

8 How much do you spend or authorize per year professionally on electronic components and/or equipment. (If you are a member of a group deciding on this, what roughly is your contribution?)

- nil (1)
- less than Rs. 7500 (2)
- Rs. 7500 to Rs. 15000 (3)
- Rs. 15000 to Rs. 30000 (4)
- more than Rs. 30000 (5)

9 What do you look for in advertisements?

(More than one choice is possible)

- components (1)
- measuring equipment (2)
- computer hardware and software (3)
- other commercial equipment (audio, video, domestic, etc.) (4)
- books (5)
- tools (6)

Please use this space for additional comments.

Reading habits

10 On average, how thoroughly do you read *Elektor*?

- (1) all articles
 (2) most articles
 (3) a few articles
 (4) I only leaf through
 Could you estimate how many hours, on average, you spend on this during the first week or two? hours

11 On average, how thoroughly do you look at the advertisements?

- (1) I check them all
 (2) I look through most of them
 (3) I study a few
 (4) I only leaf through
 (5) I never look at them

12 How do you usually obtain *Elektor*?

- (1) on subscription
 (2) from a newsagent
 (3) from a specialist electronics shop
 (4) on loan from a friend, library

13 How often do you read the following magazines, and how do they score?

	subscriber				INDIAN					
	regular reader	occasional reader	never read it	(4)						
	(1)	(2)	(3)	(4)						
A	<input type="checkbox"/>	<input type="checkbox"/>	<input type="checkbox"/>	<input type="checkbox"/>	ELEKTOR-INDIA					
B	<input type="checkbox"/>	<input type="checkbox"/>	<input type="checkbox"/>	<input type="checkbox"/>	RADIO SERVICES					
C	<input type="checkbox"/>	<input type="checkbox"/>	<input type="checkbox"/>	<input type="checkbox"/>	ELECTRONICS FOR YOU					
D	<input type="checkbox"/>	<input type="checkbox"/>	<input type="checkbox"/>	<input type="checkbox"/>	POPULAR ELECTRONICS INDIA					
E	<input type="checkbox"/>	<input type="checkbox"/>	<input type="checkbox"/>	<input type="checkbox"/>	INSTRUMENTS & ELECTRONICS					
F	<input type="checkbox"/>	<input type="checkbox"/>	<input type="checkbox"/>	<input type="checkbox"/>	TELEVISION FOR YOU					
G	<input type="checkbox"/>	<input type="checkbox"/>	<input type="checkbox"/>	<input type="checkbox"/>	ELECTRONICS TODAY					
H	<input type="checkbox"/>	<input type="checkbox"/>	<input type="checkbox"/>	<input type="checkbox"/>	DATA QUEST					
I	<input type="checkbox"/>	<input type="checkbox"/>	<input type="checkbox"/>	<input type="checkbox"/>	COMPUTER AGE					
J	<input type="checkbox"/>	<input type="checkbox"/>	<input type="checkbox"/>	<input type="checkbox"/>	PLUS					
					FOREIGN					
K	<input type="checkbox"/>	<input type="checkbox"/>	<input type="checkbox"/>	<input type="checkbox"/>	ELECTRONICS & COMPUTING					
L	<input type="checkbox"/>	<input type="checkbox"/>	<input type="checkbox"/>	<input type="checkbox"/>	ELECTRONICS TODAY INTERNATIONAL					
M	<input type="checkbox"/>	<input type="checkbox"/>	<input type="checkbox"/>	<input type="checkbox"/>	EVERYDAY ELECTRONICS					
N	<input type="checkbox"/>	<input type="checkbox"/>	<input type="checkbox"/>	<input type="checkbox"/>	PRACTICAL ELECTRONICS					
O	<input type="checkbox"/>	<input type="checkbox"/>	<input type="checkbox"/>	<input type="checkbox"/>	TELEVISION					
P	<input type="checkbox"/>	<input type="checkbox"/>	<input type="checkbox"/>	<input type="checkbox"/>	WIRELESS WORLD					

Readership profile

15 Is electronics your hobby or profession?

- (1) hobby
 (2) profession
 (3) both

16 Age:

- (1) 17 or under
 (2) 18-21
 (3) 22-25
 (4) 26-30
 (5) 31-40
 (6) 41-50
 (7) 51-60
 (8) Over 60

17 Occupation:

- (1) student
 (2) self-employed
 (3) in teaching
 (4) employed
 (5) not employed
 (6) retired

18 Education in electronics:

- (1) corporate engineer
 (2) professionally qualified

- (3) qualified technician
 (4) no formal qualifications

Other education:

- (5) Post Graduate
 (6) Technical Degree
 (7) University degree
 (8) H.S.C.
 (9) Diploma
 (10) S'S.C

19 If you are a subscriber or read *Elektor* more or less regularly: since when?

- (1) recently
 (2) about a year
 (3) about two years (UK ed)
 (4) three to five years (")
 (5) more than five years (")

20 In what country/ state/ city do you live?

Country
 State
 City

14

	very good					
	good	average	poor	very poor	(5)	
	(1)	(2)	(3)	(4)	(5)	
A	<input type="checkbox"/>	<input type="checkbox"/>	<input type="checkbox"/>	<input type="checkbox"/>	<input type="checkbox"/>	A
B	<input type="checkbox"/>	<input type="checkbox"/>	<input type="checkbox"/>	<input type="checkbox"/>	<input type="checkbox"/>	B
C	<input type="checkbox"/>	<input type="checkbox"/>	<input type="checkbox"/>	<input type="checkbox"/>	<input type="checkbox"/>	C
D	<input type="checkbox"/>	<input type="checkbox"/>	<input type="checkbox"/>	<input type="checkbox"/>	<input type="checkbox"/>	D
E	<input type="checkbox"/>	<input type="checkbox"/>	<input type="checkbox"/>	<input type="checkbox"/>	<input type="checkbox"/>	E
F	<input type="checkbox"/>	<input type="checkbox"/>	<input type="checkbox"/>	<input type="checkbox"/>	<input type="checkbox"/>	F
G	<input type="checkbox"/>	<input type="checkbox"/>	<input type="checkbox"/>	<input type="checkbox"/>	<input type="checkbox"/>	G
H	<input type="checkbox"/>	<input type="checkbox"/>	<input type="checkbox"/>	<input type="checkbox"/>	<input type="checkbox"/>	H
I	<input type="checkbox"/>	<input type="checkbox"/>	<input type="checkbox"/>	<input type="checkbox"/>	<input type="checkbox"/>	I
J	<input type="checkbox"/>	<input type="checkbox"/>	<input type="checkbox"/>	<input type="checkbox"/>	<input type="checkbox"/>	J
K	<input type="checkbox"/>	<input type="checkbox"/>	<input type="checkbox"/>	<input type="checkbox"/>	<input type="checkbox"/>	K
L	<input type="checkbox"/>	<input type="checkbox"/>	<input type="checkbox"/>	<input type="checkbox"/>	<input type="checkbox"/>	L
M	<input type="checkbox"/>	<input type="checkbox"/>	<input type="checkbox"/>	<input type="checkbox"/>	<input type="checkbox"/>	M
N	<input type="checkbox"/>	<input type="checkbox"/>	<input type="checkbox"/>	<input type="checkbox"/>	<input type="checkbox"/>	N
O	<input type="checkbox"/>	<input type="checkbox"/>	<input type="checkbox"/>	<input type="checkbox"/>	<input type="checkbox"/>	O
P	<input type="checkbox"/>	<input type="checkbox"/>	<input type="checkbox"/>	<input type="checkbox"/>	<input type="checkbox"/>	P

RS 232 analyser

Parts list
(components for one circuit)

Resistors:

R1 = 8k2
R2, R5 = 1k2
R3, R6 = 120 Ω
R4 = 18 k

Semiconductors:

D1, D2 = LED, red
or
D1 = LED, red
D2 = LED, green
T1 = BC 549C
T2 = BC 559C

enables true 'on line' testing

To be able to use a computer properly, you need a number of relevant peripheral units. These units are often connected to the computer via a serial interface V24 or RS 232. If anything goes wrong, or is suspected of having gone wrong, the analyser described here may prove to be very useful. It is simply connected in series with the relevant line. The additional load on the line is so small that true 'on line' testing is possible. The circuit consists of two transistor drivers for two LEDs: red/red or red/green. With positive levels, in the range of about 4.5 . . . 5.5 V, T1 conducts and D1 lights. With negative levels, of the order of -5.5 . . . -7.0 V, T2 conducts and D2 lights. If R4 is reduced to about 15 k, the circuit becomes active at about -3.5 . . . -5.0 V. It should be noted here that in the RS232 negative levels correspond to logic 1, and positive levels to logic 0!

The printed-circuit board can house four of these circuits, so that one board can monitor, for instance, signals RxD, TxD, RTS, and CTS which are, in the majority of cases, the most important. If you want to, or must, monitor more signals, all you have to do is to build more

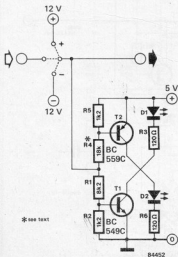
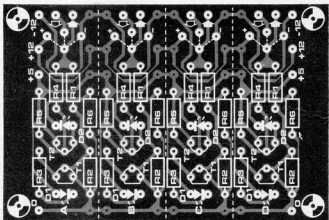
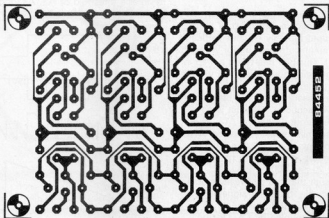

RS 232



- 1: protective earth
- 2: TxD
- 3: RxD
- 4: RTS
- 5: CTS
- 6: DSR
- 7: GND (Signal)
- 8: DCD
- 20: DTR

boards. The wire bridges make it possible to hold certain signals at a fixed level during testing. If the boards are fitted into a case, it is, of course, possible to replace these bridges by switches mounted at the front of the case.

Current consumption in each circuit amounts to 150 μ A under no-signal conditions, and to 27 mA with signal. In most cases, the supply can therefore be taken from the +5 V line in the computer.

The wiring layout of the plug is shown for the computer side of the connecting cable.



funny bird

chirps back at you

Birds of all sorts are lovingly owned by many people, but most of them have, unfortunately (?), not yet learnt to communicate with us (or we with them?). Our bird has taken a step in the right direction: when you whistle at it, it chirps back.

The necessary circuit has been split into two sections. The first is constructed around opamps A1 . . . A4. The incoming whistle received by the microphone is amplified in A1 the gain factor of which can be set between 20 and 500 by P1.

To ensure that the bird really reacts to a whistle, the input signal is filtered in A2. It is then rectified by D1 and decoupled by C5. Opamp A3, fundamentally a trigger with hysteresis, functions here as a monostable multivibrator (MMV). Its output (with an incoming whistle) remains logic 0 until C5 has discharged via R8 to such an extent that the

voltage across it lies below the hysteresis threshold of A3. As long as the output (pin 8) is logic 0, p-n-p

transistor T2 conducts and connects the earth return of the supply to the second section of the circuit. As opamps A1 . . . A3 require a symmetrical supply, impedance inverter A4 produces a voltage whose level is half that of the supply voltage, and which is applied to the non-inverting inputs of the other opamps. As long as the output of A3 is low, T1 conducts and consequently short-circuits the microphone, which is necessary to avoid positive feedback. Delay network C2/R3 ensures that T1 continues to conduct for an instant after A3 has changed state. The response of the bird emanates from the second section of the cir-

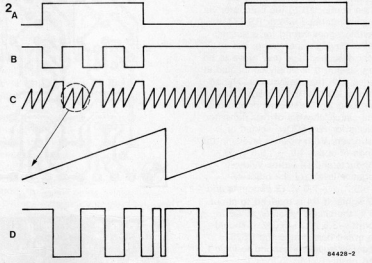

84428-2

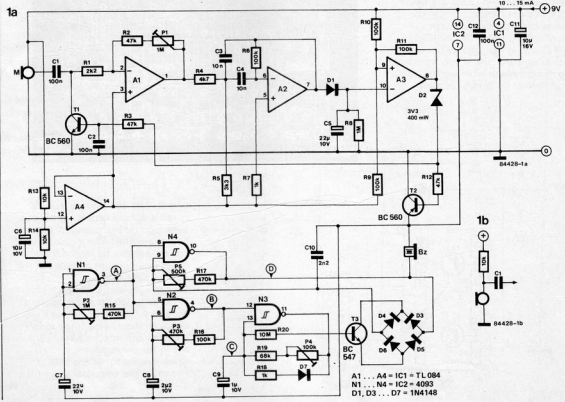

cuit, more precisely a voltage-controlled oscillator (VCO) formed by N4, D3 . . . D6, T3, and associated components. If the base of T3 is provided with a sawtooth pulse train at a rate of a few hertz, a chirping noise is produced.

The sawtooth signal is generated by gates N1 . . . N3. NAND gate N1 provides a square wave to oscillator N2, which functions only when the output of N1 is logic 1 (see figure 2). When the output of N2 is logic 1,

sawtooth generator N3 produces a pulse train as shown in figure 2C. The ensuing noise cannot, however, be heard because the VCO is blocked by the output signal of N1 at pin 8 of N4.

As soon as the output of N2 becomes logic low, N3 ceases to oscillate and its output voltage tends to rise to the positive supply level. It is because N2 and N3 oscillate at different frequencies that a totally arbitrary sawtooth signal ensues. That

signal is then pulse-frequency modulated by N4 to drive the piezo buzzer. The frequencies of the oscillators may be varied with P2 . . . P5 as appropriate, so that a range of bird sounds can be produced.

When a two-terminal instead of a three-terminal electret microphone is used, the input circuit should be altered as shown in figure 1b.

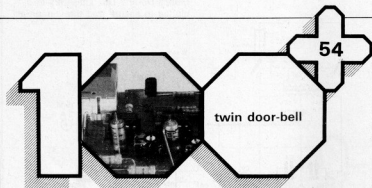

with one push-button

The present circuit is particularly useful where two families share one house, and where therefore two doorbells are a godsend, but where for one reason or another two push-buttons cannot be fitted. The only solution is then to operate the two bells with one push-button.

When the button, S1, is pressed briefly, bell 1 sounds, and when it is pressed for a longer time, bell 2 will ring. Pressing the button triggers

monostable multivibrator (MMV) IC1. The consequent logic 1 at the output (pin 3) causes T1 to conduct and this connects the clock input (pin 11) of D-type bistable IC2 to earth. This state does not last long, however, because as soon as the output of IC1 returns to logic 0, transistor T1 cuts off, and the clock input of IC2 goes high.

When S1 is pressed for an instant only, that is, it is open again at the trailing edge of the output of the MMV, the D input of IC2, and con-

sequently the Q output, goes high. The Q output (pin 13) is applied to one of the inputs of AND gate N1. The other input of N1 receives a high signal from IC4 (pin 3) and this lasts longer than the Q output of IC2. The output of N1 is then logic 1 which causes T2 to turn on and this results in triac Tri1 firing: bell 1 then rings. When the button, S1, is pressed for a longer time, it is still closed at the trailing edge of the output of IC1. Consequently, the D input of IC2 is low, and the Q output is high. This output is applied to one of the inputs of AND gate N2. The other input of N2 is in parallel with the second input of N1. From here on the circuit action is similar to that described above, but in this case T3 conducts to turn on triac Tri2 and this causes bell 2 to ring.

The width of the pulses caused by the closing of S1 is preset by P1, while the duration of the ringing, is determined by P2.

The two triacs make it possible for a standard bell transformer to be used.

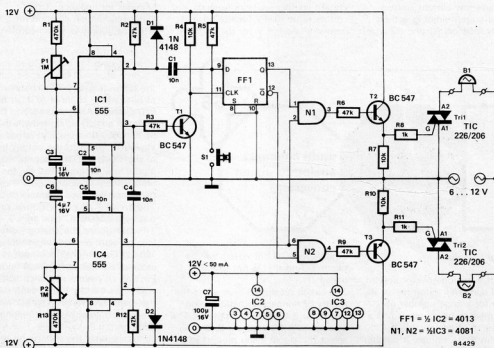

high-power op-amp supply

+ and -15 volts at 2 amps

There is often a need for a high-power no-nonsense supply for a circuit with a large number of op-amps and other (linear) ICs. A variable supply with current limiting and other special functions would increase the price and complexity unnecessarily for most applications. What is needed in many cases is a straightforward design that does what is demanded: supply-power. No more and no less.

The LM 325 voltage regulator that forms the heart of this circuit is unusual in that it provides symmetrical output voltages of + and -15 V. This is made possible by the inclusion of both a positive and a negative regulator in the same chip. In normal operation the B (boost), R_{CL} ($R_{\text{current limit}}$) and sense pins for both positive and negative regulators are connected together. The current is then internally limited to 100 mA, which is far from the high power we had in mind.

All is not lost yet, however, as two external transistors can be driven by the B outputs and thus compensate for the chip's low current limiting. The actual current limiting is then decided by resistors R1 and R2 which

protect both transistors and the IC. As soon as the voltage across the current limiting resistors exceeds a certain value (0.7 V for the positive regulator and 0.6 V for the negative,

at 25 °C) the current limiting comes into play. This occurs at a current of about 2 A with the resistor values given.

The purpose of the 10 μF capacitors at the outputs is to prevent the circuit from oscillating and so C10 and C11 should be placed as close as is physically possible to the IC. These two capacitors should be tantalum types as should C9.

The transistors must be sufficiently cooled as they can get quite warm. Finally, as regards the function of diodes D5 and D6. These are included to ensure that the voltage at

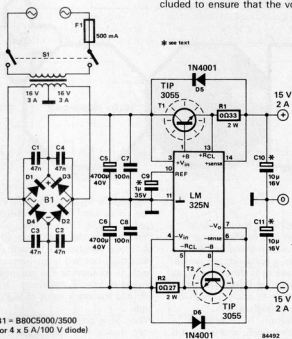

B1 = B80C5000/3500
(or 4 x 5 A/100 V diode)

1N4001 84492

the output can never become much greater than at the input. This could happen, for instance, if the capacitors remain charged for a time after the supply is switched off.

multi-channel analog-to-digital converter

for control computers

The use of a microprocessor system as control computer often makes it necessary for a large number of analog signals to be monitored. If a certain degree of accuracy is expected from these signals, a number

of suitable A/D converters will be needed. And that is not exactly cheap . . .

The circuit presented here offers the facility of connecting eight analog signals to a CD 4051 multiplexer. The channel select inputs, A, B, and C, select the signal being monitored at

the time: at binary 000, channel AN0; at binary 001, channel AN1; at binary 010, channel AN2; and so on. The selected analog signal (which must lie between 0 and +5 V) is passed straight through to the output (pin 3) of the CD 4051. The channel select inputs may be controlled by, for example, three lines from port B of a peripheral interface adapter (PIA).

The actual A/D conversion is carried out by a CMOS IC type ADC804. This transforms the analog signal into an eight-bit data word within 100 μs . The on-chip clock needs an external RC network (pins 4 and 19). Pin 9 must have a reference voltage which lies exactly in the centre of the measuring range. The conversion process commences at a leading edge on pin 3 (WR) and simultaneously the voltage on pin 5

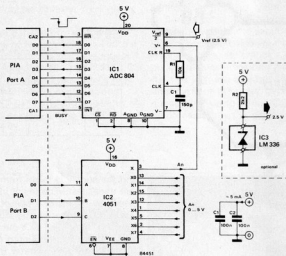

becomes 5 V at the trailing edge. After $100 \mu\text{s}$ pin 5 becomes 0 V and the 8-bit data word is then available at the port A inputs ($D_0 \dots D_7$). As there are 256 possible combinations, and the measuring range is five volts, each step is 19 mV 'wide'.

The circuit may be used with practically any microprocessor system which has a port available (PIA 6520-21; PIA 8250-21; VIA 6520; VIA 6522; Z80-PIO; 8255; etc.). Programming is dependent upon the requirement. For relatively slow operations, such as heating control, alarm systems, weather stations, and similar, BASIC may be used with PEEK and POKE instructions. With on-line controls, and maybe even with model railway control, it will normally be necessary to use a machine code program which is much faster.

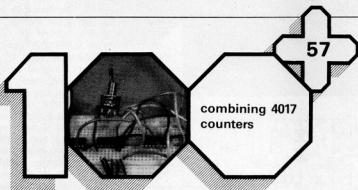

$5 \text{ V} < U_B < 15 \text{ V}$
 $N1, N3 = 1/2 \text{ IC2} = 4081$
 $N2, N4 = 1/3 \text{ IC3} = 4049$
 $\text{IC4} \dots \text{ICn} = 4017$

extends their usefulness

The well-known CMOS IC type 4017 is a decade counter which offers an excellent means of sequentially scanning small matrices. However, it may also be used as a programmable frequency divider.

There are occasions when one counter or divider is not enough to provide the required function. One way of resolving this difficulty lies in combining a number of 4017s as shown in the accompanying diagram. The AND gates, $N1, N3, \dots$, together with inverters $N2, N4, \dots$, ensure that the output level at Q_9 of each of the counters is retained at their own output terminal. The length of the counter/divider chain is determined simply by a jump connection (with $S1$ closed). When switch $S1$ is closed momentarily, the chain will cycle through just once if A is connected to pin 11 of IC_n . The counter chain may also be used as the basis of a simple waveform generator. For that application the outputs of the counters are each applied via different value resistors to the inverting input of a type 741 opamp.

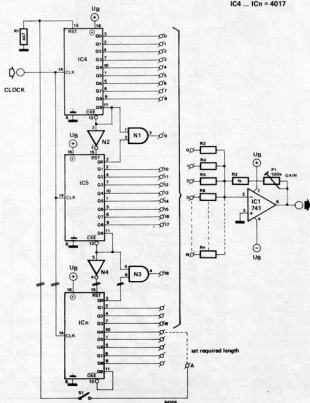

V. Johnson

digiLED

Table 1

		switching levels	
TTL	5 V	L → H	1.67 V
		H → L	1.18 V
CMOS	5 V	L → H	2.67 V
		H → L	2.23 V
	15 V	L → H	8.10 V
		H → L	6.68 V

for testing digital circuits

This design is a somewhat unusual test aid for digital circuits. Most such circuits are usually tested in a static state to provide time to look at the logic levels at various points by making d.c. measurements. This is often not good enough, however, considering the various clock signals, resets, and trigger pulses that make a circuit 'tick'. What this really demands is a tester that can also detect single pulses.

As the circuit diagram shows, either CMOS or TTL can be catered for

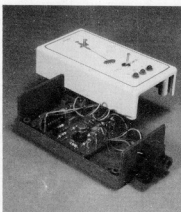

and the supply is taken from the circuit under test. The tester indicates clearly by means of a pair of LEDs (D5 and D6) whether the logic level tested is '0' or '1'. The input is fed into the non-inverting input of a schmitt trigger comparator (IC1). The inverting input of this 3130 is fed from one of two fixed reference levels depending on whether CMOS or TTL is selected. The hysteresis inherent in a schmitt trigger ensures that a 'dead zone' must first be passed before the circuit reacts to the change in input level. This means that when a change of level is indicated there is absolutely no doubt that the transition has taken

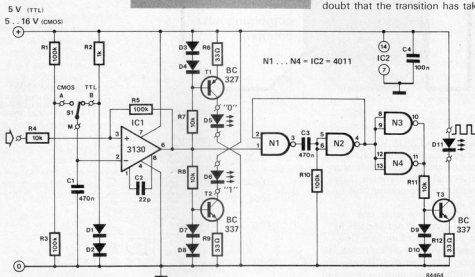

Parts list

Resistors:

R1, R3, R5, R10 = 100 k
R2 = 1 k
R4, R7, R8, R11 = 10 k
R6, R9, R12 = 33 Ω

Capacitors:

C1, C3 = 470 n
C2 = 22 p
C4 = 100 n

Semiconductors:

D1 ... D4,
D7 ... D10 = 1N4148
D5, D6, D11 = LED
T1 = BC 327
T2, T3 = BC 337
IC1 = 3130
IC2 = 4011

Miscellaneous:

S1 = single pole toggle switch

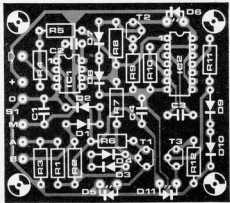
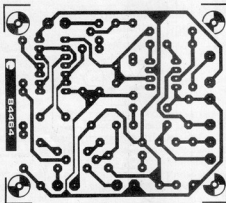

place. The exact switching points measured in our prototype are given in the table.

Pulses are detected by the section consisting of N1 . . . N4, T1, and the associated components. The monoflop consisting of N1 and N2 (and C3 and R10, of course) reacts to a high to low transition at the input and lights LED D11 for a certain length of time (long enough for it to be no-

ticed). Pulse trains also cause D11 to light but, in this case, continuously as the monoflop time bridges the pulse interval. At the same time LEDs D5 and D6 also light and if both are the same colour a comparison between the brightness of the two will give a rough idea of the duty cycle of the pulse train. Frequencies of up to about 400 kHz can be processed by the circuit. The cur-

rent consumption of the tester is about 50 mA. Building this circuit is simplified by using the printed circuit board we have developed. The design is given here and also in the service pages in the centre of this issue. It is not available through the EPS service. This is not, however, a major drawback to making this simple but useful logic tester. ■

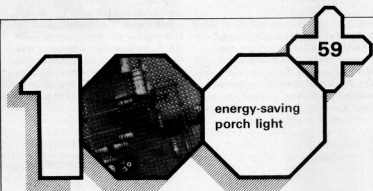

energy-saving porch light

switches itself on (and off)

This circuit forms a switch that can be triggered on (or off) at the onset of darkness and remain active for a period that is variable from thirty minutes to five hours. The main design consideration was that of keeping power consumption to a minimum while retaining a fair degree of versatility. The primary purpose was to provide an economical porch light but the circuit can obviously be used for any short-term switching application that is referenced to ambient light levels. In spite of its simplicity the circuit is relatively sophisticated. The basis of the circuit is a 14-stage ripple counter with an internal clock oscillator contained in the 4060 (IC1) which does most of the work. The frequency of the oscillator is determined by C3, R6, and potentiometer P1 which enables the frequency to be adjusted. The clock is started when a logic 0 reaches the reset input of IC1. This is achieved by the light-dependent resistor R14 and the components associated with gate N1. When the ambient light level drops, the resistance of the LDR increases and causes the output of N1 to revert to logic 0. The point at which this occurs can be determined by the setting of P2. It is worth noting that, although not desirable for this particular application, if the ambient light level increases again for any reason for a period of not less than 10 . . . 20 s, the counter will be reset and the clock oscillator will stop. In the normal course of events, the

sistor T1 when the output of N2 is logic 1. It will be apparent that the triac will therefore only be switched on when the mains power supply is at zero potential — an ideal situation! The light La will thus be switched on until such time that the count cycle of IC1 causes its Q14 output to change to logic 1. This will then halt the clock oscillator via diode D2 and maintain the high logic level at the Q14 output. At this time, gate N2 will find a '1' at

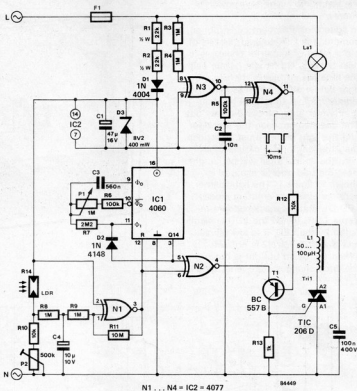

output of gate N2 will be at logic 1 while the 4060 continues to count up and transistor T1 will be controlled by the output of gate N4. The two gates N3 and N4 together form a simple, but effective, mains zero crossing point detector. This results in the output of N4 providing a short pulse at each zero crossing point of the mains cycle. It is this pulse that is used to trigger the triac via trans-

istors N2 will therefore return to a low level and switch the light off. Power levels up to 100 W can be switched by a TIC 206D unaided. However, if higher power levels (up to 500 W) are contemplated, the triac must be provided with a heat-sink, for instance, an SK13. The switched time period is adjustable by P1, ■

electronic mousetrap

humane solution to an old problem

This mousetrap is not intended to kill a mouse with the aid of electronics, but rather to imprison it in a gentle way. Afterwards, it may be given its freedom in a suitable area.

The principle of the trap is the age-old trap-door up-dated by being operated electronically. Figure 1 shows the construction of the device. In this, a small wooden box is divided into two chambers: the larger one is fitted with the trap-door, while the smaller one contains the electronic circuit and power supply.

In spite of the modern construction, some bait is still required, and as of old a piece of bacon or cheese is best for this. On its way to the bait the little rodent breaks the beam of a light barrier and this causes an electro-magnet to release the trap-door which then blocks the way out. The distance between the trap-door and the light barrier must be longer than the length of a mouse otherwise the animal's tail will be caught. How the trap-door is released is shown in figure 1. The light barrier consists of a light-emitting diode, LED D1, and a light-dependent resistor, LDR. When the LDR is illuminated by the LED, it is low-ohmic, and the latch N1/N2 is not set. When the beam of light is broken, the latch changes state, and the con-

sequent logic 1 at the output of N2 triggers monostable multivibrator (MMV) N3/N4 which then imparts a pulse to driver T1/T2. The width of this pulse is about one second which is sufficient to actuate the electro-magnet which then releases the trap-door. Latch N1/N2 ensures that once the circuit is triggered, it does not re-

1

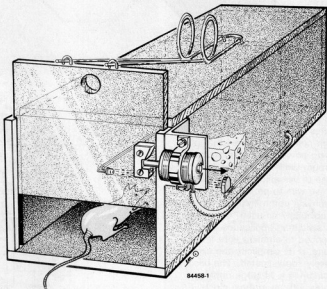

8445B-1

2

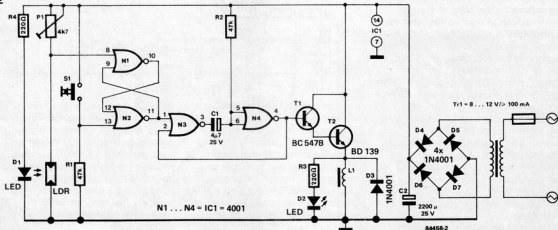

61

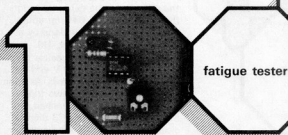

fatigue tester

react at the speed of light

The human eye has a certain 'built-in' delay. This fact is used for films, TV sets, and fluorescent lights, as above a certain flash frequency the eye does not notice any lack of continuity. It has now come to light that the highest frequency flashing a person can detect is adversely affected by tiredness and alcohol consumption. A very small circuit is all that is needed to determine exactly what

this frequency is at any time of the day or night. As the diagram shows, the circuit is very simple. It is based on an old favourite, the 555 timer, which is connected here as an astable multivibrator. Its output is connected to a LED that flashes at a certain frequency. This frequency can be varied between 20 and 50 Hz using potentiometer P1. The highest frequency that most people can detect

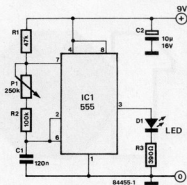

is between 30 and 40 flashes per second, but one test we conducted on a Monday morning produced a startling number of blank stares accompanied by the question 'What LED??'.

Given the nature of the circuit, it is not surprising that the current consumption is only about 25 mA so a 9 V battery is all the power that is needed.

62

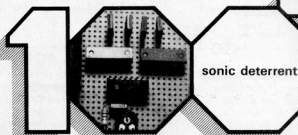

sonic deterrent

for keeping nasty rodents at bay

Most of us will agree that rats and mice are generally not the most welcome visitors to our homes. At the same time, many of us are definitely averse to killing these animals. For them, the present unit may be a godsend, although house pets may not agree. This is because the unit emits a fairly high note from a loudspeaker to frighten away our unwanted visitors.

A 4047 CMOS IC is arranged to operate as a relaxation oscillator whose frequency may be set between 5 kHz and 30 kHz with preset P1. Outputs Q and \bar{Q} are each applied to a type 4050 non-inverting driver, IC2 and IC3. The six stages contained in these ICs are connected in parallel to enable direct driving of T1/T2 and T3/T4 respectively. Either T1 and T4 or T2 and T3 conduct simultaneously. These transistor pairs are capable of driving a low-cost piezo tweeter.

A simple mains power supply may be

built as shown in the figure. Unfortunately, we cannot vouch for the effectiveness of the circuit. We would, however, advise you to change the frequency from time to

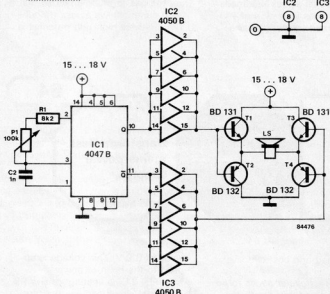
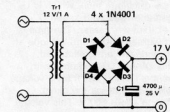

time to prevent the little animals getting used to the sound. But, as we said, we don't know how your cat, dog, or canary is going to like all this.

stroboscope

motion study by flash-light

WARNING! The circuit of the stroboscope is connected directly to the mains and experiments on the opened unit are therefore highly dangerous. Even after the unit has been disconnected from the mains, some capacitors may still give you a lethal shock! Preset P1 must have a nylon spindle and be fitted so that none of its metal parts can be touched: ignoring this may be lethal.

The heart of the unit is, of course, the gas-discharge tube, which is U-shaped and filled with xenon (Xe - one of the inert gases). The tube is fitted with an anode and cathode at either end, and an ignition grid. Diodes D1 and D2, together with capacitors C1 and C2, form a voltage doubler which raises the direct voltage to about 600 V. This voltage is applied to the anode and cathode of the tube.

Normally, xenon (and other gases) is a poor conductor of electricity but the electric field resulting from the 600 V potential across the anode and cathode causes ionization of molecules and atoms in the im-

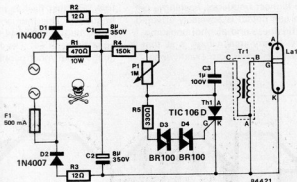

mediate vicinity of these electrodes. The gaseous ions are attracted to the charged electrodes and a small preconducting current flows. A grid potential of 5 . . . 10 kV is required to fire the tube, which means causing the gas to break down so that a large current flows across the tube. The relatively high grid potential is

obtained from ignition transformer Tr1. To cause a high potential across the secondary, the current through the primary should be interrupted very rapidly and this is done by a silicon-controlled rectifier, Th1. Capacitor C3 charges because the voltage across C2 is 300 V and the primary of Tr1 is low-ohmic. As soon as the threshold of the two trigger diodes, D3 and D4, is reached, the SCR is fired. Capacitor C3 then discharges rapidly via the primary winding of Tr1 which induces a very high voltage in the secondary and this in turn causes the xenon tube to fire.

The setting of preset P1 determines the charging rate of C3 and therefore the firing rate of the discharge tube. Resistor R1 is connected in the neutral line to serve as a current

limiter, because when the discharge tube is firing it is a virtual short-circuit; without R1 the fuse F1 would blow instantly. The discharge tube, which should be of the 60 W/s type, is normally provided complete with ignition transformer. The anode is usually indicated by a red dot.

transformerless
mains power
supply

space saving and cost effective

Warning! This circuit needs to be constructed and wired with the greatest care as the full mains voltage is present at several points.

The pulsating direct voltage provided by rectifier D1 . . . D4 has a peak

value of 310 V. This voltage is applied to the drain of power MOSFET T1 via limiting resistor R9. A control circuit ensures that the MOSFET only conducts during the short times just before and after the mains voltage goes through zero. During these times the momentary value of the pulsating direct voltage

does not exceed 5 V. In the same short times smoothing capacitor C2 is charged: during the remainder of the time it provides the output current. Consequently, this capacitor has a very high value: 10 000 μ . The load-current pulses have a peak value, if only for a brief moment, of the order of 4 A!

The stability of the output voltage is essentially dependent upon the load. The output current may be 110 mA maximum. The supply for the control circuit is provided by resistor R2, capacitor C1, and diodes D5 and D6. The control circuit is a window comparator constructed from three opamps. Correct calibration of the control circuit is therefore very important. Before the mains is applied for the first time, set P1 to the centre of its travel and turn P2 so that its wiper is at earth potential. Then connect the mains and check

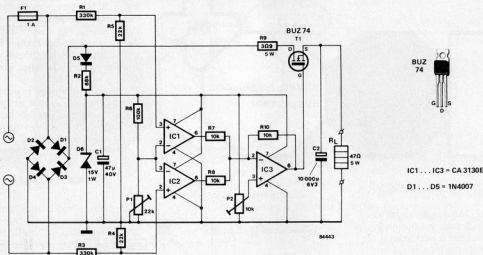

the operating voltage of the circuit. Next connect a voltmeter (10 V dc range) at the output and adjust P2 until the meter just begins to deflect. Finally, adjust P1 for a meter reading of 4.8 . . . 5 V. Applications of the circuit are restricted. It is evident that it cannot be used with equipment which should be electrically isolated from the mains. It is equally unsuitable for

use with equipment that is allergic to mains spikes and noise. It is, however, eminently suitable where there is no space for a mains transformer. The unit should only be used for powering equipment that is contained well-insulated in a plastic case. Any equipment powered by the present unit should not be connected to other equipment by cable. Such connections, if necessary, should be

by opto-coupler only. Heat dissipation in T1 and R9 amounts to only about 3 W so that even if the circuit is fitted in a small case there should be no heat problems. During assembly the usual precautions relevant to mains operated circuits should be observed scrupulously.

Siemens application note

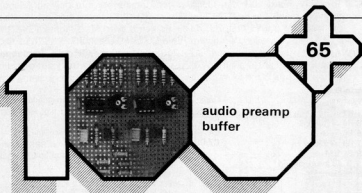

audio preamp buffer

with variable gain

The design for the circuit here was created when problems arose with the matching of some output stages with a preamp. In effect, the circuit is simply what the title suggests, a buffer between an audio preamplifier and an output stage. It does have the added facility however, of being able to drive more than one output amplifier simultaneously.

The preamp load is standard at 100 pF in parallel with 47 k. To be fully versatile it was considered that the opamp used must be capable of driving similar loads at a level of 10 V without a problem. The LF 356 shown here can manage this. The amplification factor is adjustable between 1 and 5 with the aid of the preset potentiometer in the feedback loop of the opamps. These also serve to balance the output levels of

the two buffer stages. If required, the balancing can be achieved very easily by means of a 50 Hz signal source and an ordinary multimeter. The 50 Hz is applied to both inputs of the buffer circuit and one preset is adjusted to provide the required gain factor. The multimeter, switched to a suitable ac range, is then placed between the two outputs. The second preset is now adjusted to produce a zero reading on the meter.

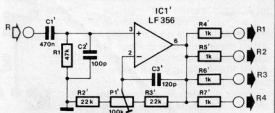
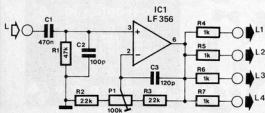

stereo noise suppressor

9...30 V, when wire bridge 'A' on the printed-circuit should be fitted. When a 5...15 V symmetrical supply is used, wire bridge 'B' should be fitted, R2 should be replaced by a wire bridge, and R1 and C3 are omitted.

NOTE: a ready-etched printed-circuit board for this project is not available: it can, however, be made from the layout (ref. 84446) given in the pc board pages in this issue.

depends on channel separation

Weak VHF/FM signals, particularly stereo broadcasts, are normally received against a background of noise. When the receiver is then switched over to mono, much of the noise disappears, but so, unfortunately, does the stereo effect. The present circuit reduces the noise drastically, but does not eliminate the stereo effect. A potentiometer allows selection of the best compromise between noise and channel separation. The circuit is simply inserted between the tuner and the amplifier. Inputs and outputs are isolated from direct voltages by coupling capacitors C1, C2, C5, and C6. The input impedance is of the order of 100 k because of resistors R3 and R4 which also provide a direct voltage to operational amplifiers IC1 and IC2. This voltage is half the supply voltage because of voltage divider R1/R2 which is decoupled by C3. The opamps function as impedance inverters with unity gain. Their outputs are taken to a stereo potentiometer, the minimum value of which is limited to 3k3 by resistors R5 and R6. The output terminals of the two sections of the potentiometer are shunted by capacitor C4 when switch S1 is closed. This capacitor causes frequency-dependent cross-talk between the channels and the consequent decrease in channel separation provides a reduction in noise. The capacitor therefore acts as a low-pass filter. The frequency response of the composite signal is not affected by the action of C4: the difference signal (the stereo component) is, however, attenuated at a rate of 6 dB/octave. The cut-off frequency of the low-pass filter may be set between 1.3 kHz and 5.1 kHz with P1. The suppressor is switched on and off by S1: with this switch open, the input signal appears unchanged at the output. The output impedance of the circuit depends on the setting of P1: its maximum value is about 14 k. Current consumption amounts to about 10 mA. As is shown in the circuit, the power supply may be symmetric or non-symmetric: in the latter case the supply voltage may be

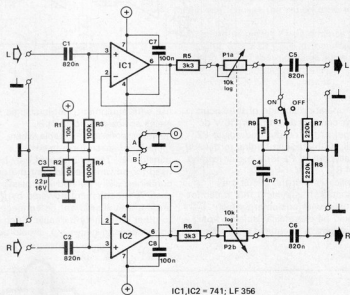

84446

Parts list

Resistors:
 R1, R2 = 10 k*
 R3, R4 = 100 k
 R5, R6 = 3k3
 R7, R8 = 220 k
 R9 = 1 M
 P1 = 10 k log, stereo potentiometer

Capacitors:
 C1, C2, C5, C6 = 820 n
 C3 = 22 µ/16 V*
 C4 = 4n7
 C7, C8 = 100 n

Semiconductors:
 IC1, IC2 = LF 356
 Miscellaneous:
 S1 = SPST switch
 * see text

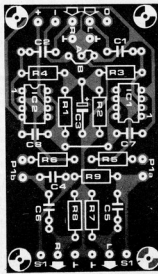
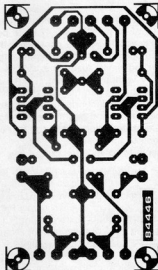

v.h.f. converter

for short-wave receivers

Many short-wave listeners often wish their receiver could be extended above 30 MHz. The converter described here makes it possible to add either the 30...60 MHz or the 60...90 MHz band to your existing receiver.

A converter transforms a certain range of radio frequencies that cannot be processed by a given receiver into one that can. Its output is normally connected to the aerial input of the receiver.

The present converter is suitable for the reception of either the 60...90 MHz or the 30...60 MHz band. It consists of an r.f. pre-amplifier, an oscillator, and a mixer. The signal picked up by the aerial is applied to a preselector consisting of tuned circuit L1-C1-D1, MOSFET amplifier T1, and tuned circuit L2-C2-D2. Diodes D1 and D2 are varactors which enable fine tuning of the two resonant circuits. A varactor is a semiconductor diode operated

with reverse bias so that it behaves as a voltage-dependent capacitor. The control voltage is derived from a multiturn potentiometer, P1, which therefore enables coarse tuning of the two circuits.

The amplified signal from the preselector is applied to mixer T2 together with a 60 MHz or 30 MHz signal generated by crystal oscillator T3. Filter L5-L6-L7-C8-C9 at the output of the mixer only passes the difference between the two frequencies, that is, about 0.1...30 MHz, which is the frequency range of most short-wave receivers.

Inductors L1 and L2 should be wound on a pencil according to table 1, while L4 consists of 4 + 1 turns on a ferrite bead. Wire to be used is enamelled copper, SWG21 for L1 and L2B and SWG23 for L2A and L4. The remaining inductors, L3, L5, L6, and L7 are standard miniature chokes.

Calibration of the converter is simple. If you have a frequency counter, adjust trimmers C3 and C4 until the

Table 1

	30...60 MHz	60...90 MHz
L1	24 turns: tap 4 turns from earth	12 turns: tap 2 turns from earth
L2B	24 turns: tap 8 turns from earth	12 turns: tap 4 turns from earth
L2A	4 turns	2 turns

oscillator operates at exactly the crystal frequency. If you have no frequency counter, just set C3 and C4 at about the centre of their travel: this is usually precise enough.

Next, the circuits in the preselector should be tuned to the wanted frequency range. Using P1, seek a signal of about 30 MHz or 60 MHz, depending on which range you have chosen, and carefully compress or elongate the turns of L1 and L2 until the received signal is strongest. Then, again using P1, find a signal at around 60 MHz or 90 MHz and adjust trimmers C1 and C2 for maximum signal strength.

The converter needs two supply voltages: a stabilized one of 12 V for most of the circuits, and a 24 V one for the tuning control. Current consumption amounts to about 40 mA from the 12 V supply, and only around 1 mA from the 24 V line.

NOTE:

A preselector improves the sensitivity and the selectivity of a radio receiver; it usually is a tuned radio frequency (r.f.) amplifier that amplifies the incoming signal before amplification and demodulation.

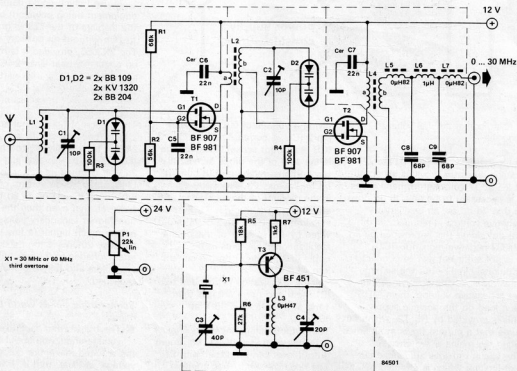

84501

screen-noise killer

for the VDU card with the CMOS Junior

The VDU card published in Elektor number 6, October 1983, sometimes lets noise appear on the screen, such as when a program is being listed. This fault can easily be remedied by means of a few gates in the VDU card that are unused in the Junior Computer/VDU card combination.

The trick of the circuit consists of stopping the processor when it attempts to write to the video RAM during the display enable time. Only the 65C02 can be stopped during writing so this circuit operates exclusively with Junior Computers equipped with the CMOS Processor. This procedure causes a slight delay

in the output of a program but this is hardly noticeable in practice.

In order to carry out the modification the following IC pins on the VDU card are bent out to the side so that

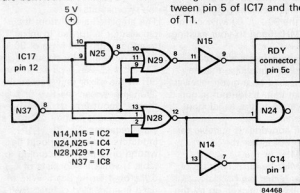

they are no longer in the IC sockets: IC2 pins 7, 9, 11 and 13; IC4 pins 1, 8, 9 and 10; IC7 pins 1, 8, 9, 10, 11, 12, and 13; IC8 pin 8; IC17 pin 1.

These pins are then connected together as indicated by the heavy lines in the circuit diagram. Pin 1 of IC17 simply remains open, while pin 2 of IC7 is already connected to ground. Note that pin 1 of IC14 and pin 12 of IC17 must remain pushed into their respective sockets even after wires are soldered onto them. Another possible 'extra' for the VDU card is to show a frame on the monitor within which all the video data is displayed. All this requires is a single 1 k resistor connected between pin 5 of IC17 and the collector of T1.

power supply considerations

a fresh look at the 723 voltage regulator

In its standard application, the 723 voltage regulator provides an output of 2...37 volts but in many cases it is necessary to be able to go down to 0 V. To do so, an auxiliary negative voltage is required: in the present circuit this is provided by an LM337 negative regulator (IC2). It is not sufficient just to connect an additional circuit onto the same transformer as the positive supply: to get a negative voltage, there MUST be a load on the positive supply. This is provided by R5/T2, which ensures that a current flows at all times when the mains is switched on. The circuit provides adjustable current limiting which is effected by ap-

plying a voltage of 0.6 V between pin 2 (CL = current limit) and pin 3 (CS = current sense). This voltage is the sum of the drops across R8 (proportional to the output current, I_O) and across P3. The latter voltage is the product of the resistance of P3 and the current through T1. Further stabilization of the base of T1 is provided by T2. In spite of this double stabilization there remains a small ripple (0.3 per cent) on the current into CL.

Voltage stabilization is provided by IC1: hum and noise are less than 1 mV at an output of 15 V at 150 mA. The output voltage increases linearly with the resistance of P2. Maximum output level can be preset with P1. The negative supply has a longer

time constant than the positive section so that when the mains is switched off, it remains active slightly longer. If this were not arranged, the output might momentarily rise (which could damage the equipment being powered) owing to the inability of the 723 to go down to zero without an auxiliary voltage. The 2N3055, provided it is mounted on a suitable heat sink (2 °C/W), can dissipate 30...40 watts. At a transformer voltage of 22 V, this means that well in excess of 1 A can be handled.

The choice of transformer is fairly critical, because strictly speaking 24 V is already slightly too high for the 723 which tolerates just about 36 V. It is therefore better to use the L146, an improved version of the 723 which can handle up to 80 V. Note, however, that even then the transformer secondary voltage should not be much higher (a few volts) because otherwise the maximum rated voltages of the electrolytic capacitors and transistors will be exceeded.

Some further points worth bearing in mind:

■ The transformer secondary voltage should be about equal to the required maximum output voltage, at least, that is, if this lies

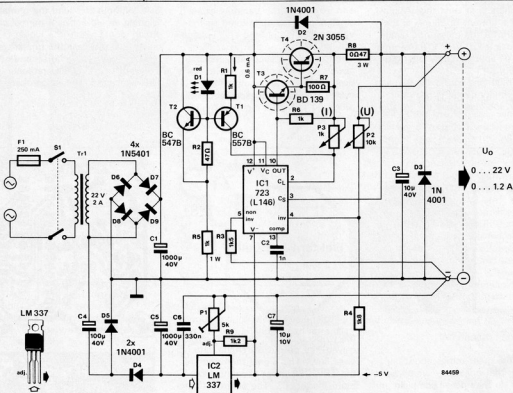

above 20 V.

Always ensure that the current rating of the transformer is at least 1.4 times the output current.

The output voltage is equal to $P2U_{neg}/R4$ volts; U_{neg} should be set at about -5 V with P1. By adjusting P1 (and therefore U_{neg}) slightly, the maximum output voltage can be set precisely to 22 V. If the

required maximum output voltage is quite different from this value, R4 has to be adapted so that U_{neg} still remains about -5 V.

The maximum output current is determined by R8 and is equal to $0.6/0.47 = 1.28$ A.

Do not allow the 3055 dissipating more than 40 W continuously!
Finally: the earth return is inten-

tionally shown as three parallel lines to give a clear point of reference where the voltage or current, in the final instance, is constant. Owing to the unavoidable voltage drops across the earth returns, regulation will always be inferior when the returns are not kept separate.

W. Vogt

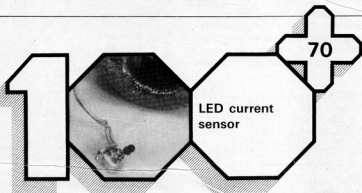

simple, but effective

It is sometimes necessary, or at least desirable, to be able to detect relatively large a.c. currents. One way of doing this is to use a LED in a network with resistors and/or 1N4001 diodes. This is, however, not such a good idea as there will always be a certain amount of voltage 'lost' across the LED if nowhere else. From a technical point of view there are better ways of detecting the current, such as using current trans-

formers. The advantages of this method are that the current to be measured can be converted to a value that better suits the measuring equipment and the transformer provides a distinct separation between the value that is measured and the measuring equipment. This latter point is particularly important as the measured value is often extremely high. Moving on to the practical side of things; we have been talking about a current transformer but what we ac-

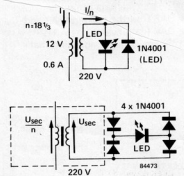

tually used is a normal mains transformer. The low-voltage winding is connected in series with the current that is to be defined. The '220 V' winding is now free to have the LED(s) or other measuring equipment connected to it. When choosing a transformer it is important to bear in mind the maximum current that is expected in the secondary winding and the maximum permitted LED current. Consider this example: the current to be detected is 0.6 A so the low-voltage winding must be

able to handle at least this. Assuming that a current of 30 mA is the maximum for the measuring circuit we choose a 220 V/12 V transformer to give us approximately the right ratio (600/30).

The voltage loss across the winding in the primary circuit is relatively small. In the ideal case the resistance

and leakage of the transformer are small enough to be ignored so the voltage loss is only the LED voltage divided by the transformer ratio. The transformer secondary must always be connected to a load, for both positive and negative half-cycles. This is the reason for adding a second LED or a diode in the cir-

cuit. Without this load the primary winding would act as a normal coil which would result in a higher voltage drop across the primary and a higher voltage at the secondary. This diode or LED also protects the LED against high reverse voltages. ■

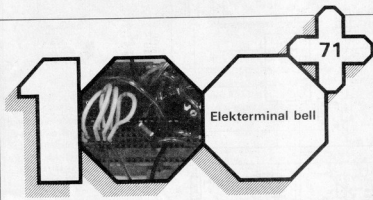

grabs your attention

One of the great things about computers is that no matter what you tell them to do they never complain and always stay quiet. Sometimes, however, it is helpful if a computer can make some noise to catch your attention. In the KB-9 BASIC or Junior BASIC the ASCII character 07 is an 'end of line' indicator, and represents 'BELL' (control + G on the keyboard). The extended Junior does not use this signal, but it can if the circuit shown here is built. The circuit diagram shows just how simple the hardware for this 'bell' is. When the ASCII character 07 (0000 0111) appears on lines B0 . . . B6 (the data output lines of the UART on the Elekterminal) and the DAV (data available, UART pin 19) line is high (indicating that

the whole character has been received) the output of NAND gate N5 goes 'low'. This signal then goes to the TRIGGER input of monostable multivibrator IC3. The external timing components connected to pins 1, 2 and 3 of this 4047B determine the width of its output pulse, and adjusting preset P1 varies this width. The Q output then goes high for a certain length of time and during this time T1 drives the buzzer. The current consumption of the circuit is no more than 20 mA.

The printed circuit board for this circuit is quite small, as could be expected. This is, of course, an advantage when you are trying to squeeze it into what little space there is available in the case of most Elekterminals. Construction is simply a matter of fitting the components onto the board and the only point of note

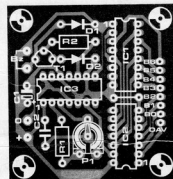
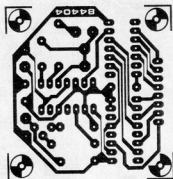

Parts list

Resistors:

- R1 = 390 k
- R2 = 12 k
- P1 = 1 M preset

Capacitors:

- C1 = 1 μ /10 V Ta
- C2 = 100 n

Semiconductors:

- D1, D2 = 1N4148
- T1 = BC 547B
- IC1 = 4049
- IC2 = 4068
- IC3 = 4047B

Miscellaneous:

- Bz = 5 . . . 6 V d.c. buzzer

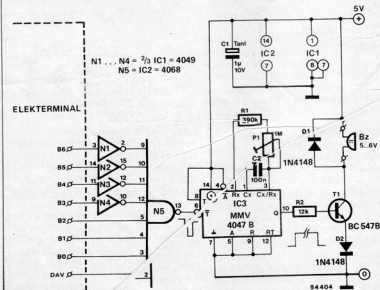

concerns diode D2. This diode may be replaced by a wire bridge if the buzzer volume is too low. The 'software' for this bell is just as simple as the hardware. In the KB-9 BASIC or Junior BASIC all it involves is:

PRINT CHR \$(7).

W. Schaij

72

stereo balance indicator

for the purist

Mechanical deficiencies that affect the sound reproduction in a stereo amplifier are perhaps the last you think about when problems are encountered. And yet, they play a larger role than is generally known. True, their effects are normally so small that few of us notice them, or ascribe them to something else. Most of such deficiencies can be traced back to the stereo volume control, in which the two resistance

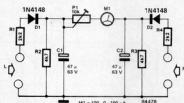

tracks are often out of step. The consequent difference in volume between the two channels can normally be evened up by the balance control. If you wish to determine the exact

difference, the present stereo balance indicator should be right up your street! Simply connect this to the left-hand and right-hand loudspeaker output terminals of the amplifier and feed equal signals — preferably sinusoidal — to the two input channels of the amplifier. If then the signals at the two loudspeaker terminals are of exactly the same level, the centre-zero meter in the balance indicator will not deflect. If, however, the level of the signal in the left-hand channel is higher than that of the signal in the right-hand channel, the meter will deflect towards the left (or to the right in the opposite case). The balance control can in that case be adjusted till the meter reads zero again: the effect of the volume control tracks being out of step has then been eliminated. Preset P1 in the balance indicator should be adjusted for full-scale deflection of the meter when only one channel is operating.

73

CPU clock generator

for frequencies up to 10 MHz

When using fast CPUs it can still be a problem to generate a good clock signal. By "good" we mean that it must have clearly defined high and low levels and it must be very symmetrical. What we are thinking about, in particular, is 8 MHz CPUs but this circuit can operate with crystals of up to 20 MHz and, more importantly, it provides an excellent clock signal.

The actual oscillator is based on a pair of inverters (N1 and N2) and it oscillates at twice the CPU frequency. Its signal is buffered by N3 and then the frequency is halved by D-type flip-flop FF1. The \bar{Q} signal from this flip-flop is buffered and inverted (by N4 and N5) and is then available for functions other than the CPU clock. The Q output, on the other hand, supplies the signal for the driver circuit for MOS levels that is based on T1 and T2. The clock signal finally output from this section

meets the following specifications:

- high clock signal minimum level: $U_+ - 600 \text{ mV}$
- low clock signal maximum level: 0.45 V
- rise time maximum: 10 ns at $<35 \text{ pF}$ load capacitance

The circuit can be used without any problems for frequencies up to 10 MHz, in which case X1 is a 20 MHz crystal.

Tekelec Airtronic

N1 ... N5 = 5/6 IC1 = 74S04
FF1 = 1/2 IC2 = 74LS74

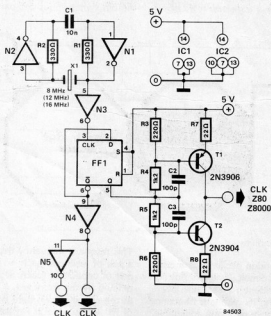

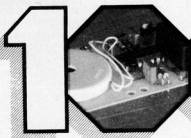

'lights on' warning

74

protects your car battery

Who has not at one time or another forgotten to switch off his car's lights on a murky morning? That is not much of a problem when colleagues or passers-by are kind enough to draw your attention to it. But if there are no such friendly souls about, you may at the end of the day find that your battery is as flat as a pancake. Some modern cars have a factory-fitted warning unit, others have their wiring arranged such that when the ignition is switched off only parking lights can be left on. The majority of cars, however, are not protected against such an oversight and it is for those that we have developed the present warning circuit. This has an advantage over other similar circuits in that you can switch on your headlights when the ignition is switched off. The circuit is based on two astable multivibrators (AMVs) of which the first is formed by NAND gates N1/N2 and associated components. It operates as a clock with a frequency of about 20 Hz. The second AMV, based on N3/N4, operates as a tone generator at a frequency of about 3300 Hz. The clock and tone generator are controlled by a transistor-relay logic

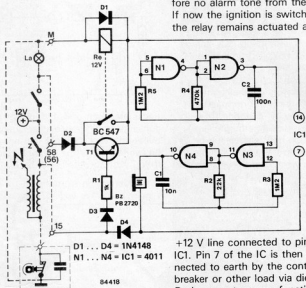

circuit which obtains its data from the car's electrical system. The warning unit is connected to the car's electrical system at terminals 15, 58 (56), and M in the circuit diagram. These are DIN designations used in the majority of cars; if yours is an exception, 15 is the ignition coil terminal, 56 is the centre contact of the dip switch, 58 is the parking light

terminal, and M is the earth. The broken lines in the circuit indicate parts already fitted in the car: L is the lights switch, Z is the ignition switch with underneath it the ignition coil and contact breaker. When with the ignition switched on, the lights are turned on, transistor T1 conducts. At the same time, relay Re is actuated and short-circuits the collector-emitter junction of T1. Although this connects the +12 V line to pin 14 of IC1, the AMV does not yet operate because pin 7 is not connected to earth. There is therefore no alarm tone from the buzzer. If now the ignition is switched off, the relay remains actuated and the

+12 V line connected to pin 14 of IC1. Pin 7 of the IC is then connected to earth by the contact breaker or other load via diode D4. Both generators now function and the buzzer emits a warning note. If the lights are then switched off, the relay is no longer actuated, and the +12 V line is removed from pin 14 of IC1, which stops the generators. If the lights are required to remain on, the lights switch can simply be turned on: the alarm will then not be actuated. H. Braubach

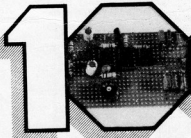

Wien bridge oscillator

75

with high stability

The Wien bridge oscillator is a commonly used circuit, which is not surprising considering that it has low distortion and its resonant frequency can quite easily be made adjustable.

This resonant frequency depends on a pair of resistors (each = R) and a pair of capacitors (each = C) and is defined by the formula $f = 1/2\pi RC$. In the circuit shown here R consists of $R1 + P1a$ (or $R2 + P1b$) and C is

either C1, C2 or C3 (or, C4, C5 or C6). The oscillator proper consists of these components together with IC1, IC2 and their associated components. Part of the output signal from IC2 is fed to the regulating attenuator consisting of IC3 and T1. This FET, which is used here as a variable resistor, is part of the feedback loop of IC2. The gain of this op-amp is thus made voltage dependent and can be changed by altering the control voltage of T1 using P2. This potentiometer must be set so that the circuit oscillates stably. The range of the oscillator, with the component values shown, is from about 20 Hz up to 22.5 kHz and distortion is no more than approximately 2%.

B.G. Lindsay

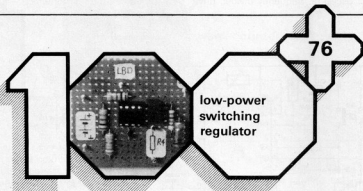
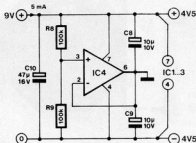
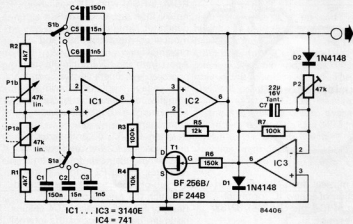

low-power switching regulator

for battery-operated equipment

The low-power switching regulator type 4193, which is housed in an 8-pin miniature DIL package, is designed specifically for battery operated equipment. A regulated power supply can be constructed for such equipment with just eleven components: five resistors, two capacitors, one diode, a choke, a 4193, and a 2.4...9.0 V battery. The output of this supply will remain near-constant at 9 V until the battery has decayed to a terminal voltage of 2.4 V. A practical circuit is shown in figure 1.

The 4193 has an internal reference circuit of which the control current, I_c , is set externally by resistor R1 connected between the battery and the I_c pin (6). This current can vary from 0.5 μ A to 100 μ A without affecting the operation of the chip. The value of R1 is given by

$$R1 = [(U_b - 1.3)/I_c] \text{ k}\Omega$$

where U_b is the battery voltage in volts and I_c is in mA.

In addition to setting bias currents throughout the chip, the reference voltage is used for the low-battery detector circuit, and to set the threshold for the input of an on-chip regulation loop for comparison with a feedback voltage, U_f (pin 7). The low-battery indicator voltage

level, U_d , is programmed by means of resistors R2 and R5. The value of R2 is given by

$$R2 = [10^3(U_d - 1.3)/5] \text{ k}\Omega$$

The integral regulation loop turns off the chip when the feedback voltage drops below 1.3 V. Capacitor C1 is the frequency determining component for the internal sawtooth oscillator in the regulation loop.

The output voltage, U_o , is given by

$$U_o = [1.3(R3 + R4)/R4] \text{ volts}$$

and is plotted (figure 2) against the output current, I_o , for various values of R4 (with R3 = 82 k Ω), and an input voltage of $U_o/2$.

Raytheon application

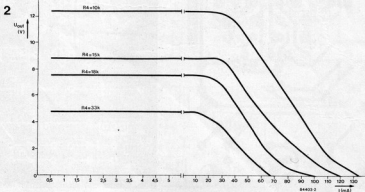
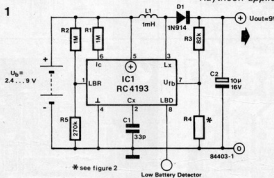

musical doorbell

ROM, a ROM with 512 musical notes, tone generator, rhythm generator, timbre generator, modulator, run-off control, and pre-amplifier.

Apart from the IC, the circuit comprises an a.c. operated power supply with voltage regulator, a push-pull amplifier for driving the loudspeaker, and a number of associated components.

Resistors R1, R2, potentiometer P2, and capacitor C2 are the frequency-determining elements for the on-chip oscillator. Preset P2 is for adjusting the run-off speed, that is, the speed at which the tune is played.

Resistor R7 and capacitor C4 ensure optimum performance of the internal modulator. Resistor R3, preset P1, and capacitor C3 form a volume control which

variations on an old theme

Although we would not like to make a habit of it, going back to an old design when new components become available is sometimes very rewarding. And so it is in this case

of the musical doorbell with the introduction of a new IC, or rather quartet of ICs, the UM 3481/82/83/84 series.

As could be expected, the principal part of the circuit is contained in the IC: oscillator, frequency divider, drive

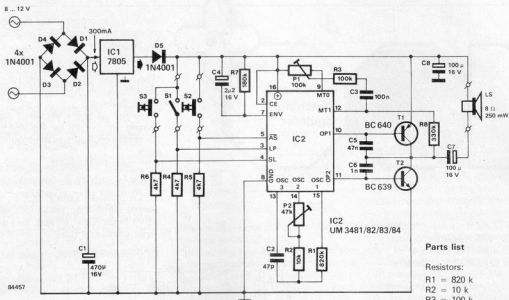

Parts list

Resistors:

- R1 = 820 k
- R2 = 10 k
- R3 = 100 k
- R4, R5, R6 = 47 k
- R7 = 180 k
- R8 = 330 k
- P1 = 100 k preset
- P2 = 47 k preset

Capacitors:

- C1 = 470 µ/16 V electrolytic
- C2 = 47 p
- C3 = 100 n
- C4 = 2µ2/16 V electrolytic
- C5 = 47 n
- C6 = 1 n
- C7, C8 = 100 µ/16 V electrolytic

Semiconductors:

- D1 . . . D4, D5 = 1N4001
- T1 = BC 640
- T2 = BC 639
- IC1 = 7805
- IC2 = UM 3481 . . . UM 3484 (see text)

Miscellaneous:

- S1 = SPST
- S2, S3 = spring-loaded push-button, press-to-make
- LS = loudspeaker, miniature, 8 Ω, 250 mW

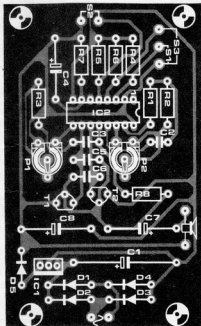
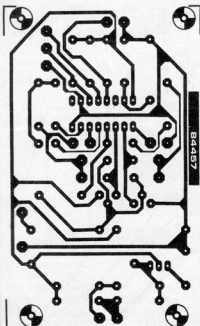

controls the on-chip pre-amplifier. The circuit is operated by S1 . . . S3 and R4 . . . R6. Switch S2 is the normal bell-push. If you want to pre-program a given melody, an additional push-button may be connected in parallel with S2. With S1 closed, all melodies stored in the ROM are sounded in sequence; when it is open, only the one selected by S3 will be played. A particular melody is chosen by closing S1 and pressing S2 con-

tinuously, while S3 is pressed repeatedly until the wanted melody has been reached. Until now, four ICs in the series have become available and these differ only in the melodies stored. The UM 3481 contains eight Christmas carols and the UM 3484 the sounds of Big Ben striking one to twelve in ascending order. The UM 3482 has twelve tunes, among which "Frère Jacques, frère Jacques", "Happy Birthday to you", and "Cradle

Song", while the UM 3483 contains melodies like "The Last Rose of Summer", "The Lorelei", and "Wedding March". At the time of going to press we understand that there may be difficulties in obtaining the UM 3481 . . . 3484 in some areas but we hope this problem will be resolved soon.

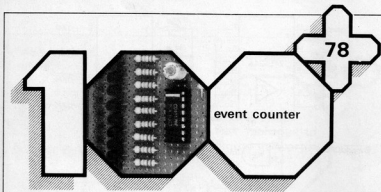

event counter

with LED indication

An event counter, as could be expected, counts events, or, to be more precise, it counts the occurrences of a particular event. The counter here may seem a bit limited, as it can only go to 99, but in fact it can be expanded almost infinitely. The read-out consists of two lines of LEDs, one for units and the other for decades. Only one LED per line (at most) will light at a time so the current consumption is quite low, certainly when compared to a set-up with 7-segment displays. The actual counter consists of two 4017 decade counters. When the reset button is pressed both Q0 outputs go high. Every clock pulse arriving at pin 14 of IC1 makes the next output of the IC go high. At every tenth clock pulse the CO output goes high and clocks IC2 and at the same time IC1 is reset to 0. After 99 pulses both IC1 and IC2 reset to zero and the sequence starts again. In principle the carry output of IC2 can be used to extend the circuit infinitely.

The outputs of a 4017 cannot drive LEDs directly so it is necessary to add a simple buffer stage, consisting of a transistor and a resistor, to each output. A single common resistor (820 Ω at 15 V supply) per line is all that is needed as each IC drives only one LED at a time. All that remains now is to consider the clock or counter pulses. Sometimes these can be taken directly from another circuit and if this is the case check that the power supply is suitable and, if necessary,

change the values of R20 and R21. In other situations the circuit based on N1 . . . N4 can be used. A clock pulse is generated every time S1 is closed or S2 is opened, and, to alleviate any problems, the effects of contact bounce are suppressed by N2, N3, C3, and R25.

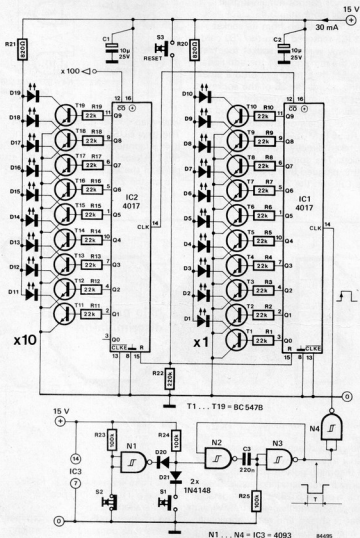

jump on reset

for the Z80 CPU card

The Z80 program commences to run at reset on address 0000. It is, however, desirable for many applications to access a RAM range (for instance, a RAM card) at this address. The present circuit ensures that the bus driver remains at high impedance until the CPU reaches, for instance, the required start address of the monitor program through execution of the hard-wire NOP instruction. As this instruction has an execution time of $1 \mu\text{s}$ (with a clock of 4 MHz), the bus driver cannot remain in that state for more than 0.06 s.

The CPU is taken from its socket and IC5 removed from the Z80 card. A 40-way wire-wrap socket together with the remainder of the additional circuit is then mounted onto a small wiring board. Pin 26 of the socket is bent because it carries the BUSACK signal of the CPU. The data and address terminals on the bus, as well as RESET, MREQ, +5 V, and earth are taken directly from the wire-wrap socket. The completed additional circuit is plugged into the socket for the CPU on the Z80 card, and the

wire-wrap socket receives the CPU. The new BUSACK signal (pin 11 of IC4) is connected to pin 26 of the old CPU socket, and pin 3 of IC3 to pin 8 of the socket for (the removed!) IC5 on the Z80 card.

From now on, R-S flip-flop N1/N2 is set on reset. The (new) BUSACK signal goes low via N5 and all bus drivers become high impedance. The NOP instruction (hex: 00) is connected to the data bus of the CPU via IC1. This instruction continues until page 4-K on address comparator IC2 (set by switches S1...S4) is reached. The flip-flop then changes state, the outputs of IC1 become high impedance, and the bus drivers are released by the BUSACK signal.

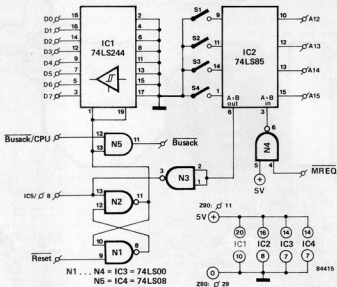

A tip: how to set switches S1...S4 as required is described in detail in 'Address Decoding' in the February 1984 issue of *Elektor*.

D. Paulsen

hi-lo pulse rate discriminator

one bit frequency meter

The circuit described here gives a visual indication whether the rate of an incoming pulse train is above or below a predetermined value. Based on a type 74LS123 dual retriggerable monostable multivibrator (MMV) with clear, it should find ready application in microcomputer systems operating

with more than one clock, for instance a TRS80 with speed-up modification. The reference rate, f_r , is determined by the time constant $R1C1$, which

with the values as shown amounts to $0.45 \mu\text{s}$ to give $f_r = 2.2 \text{ MHz}$. When the rate of the input signal, f_i , applied to A1 of MMV1 lies below f_r , output Q1 is able to follow the input

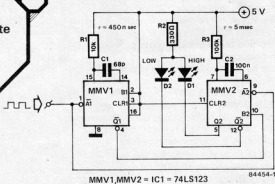

MMV1, MMV2 = IC1 = 74LS123

8445-1

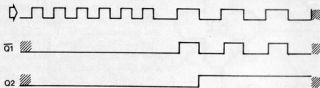

signal. Input B2 of MMV2 goes high at the leading edge of the trigger pulse, so that MMV2 accepts the negative edge trigger on input $\bar{A}2$. Output $\bar{Q}2$ then goes low, which

causes D2, the 'low' rate LED, to light. When f_j is higher than f_r , MMV1 is retriggered before its internal pulse period has lapsed. This causes out-

put $\bar{Q}1$ of MMV1 and input B2 of MMV2 to be held at low logic level. Output Q2 of MMV2 then remains low and D1, the 'high' rate LED, lights.

An error pulse of about 5 ms occurs on MMV2 when the circuit is switched on and this is indicated by D2 lighting. This 'reaction' pulse is necessary because the circuit needs at least one clock pulse to start up.

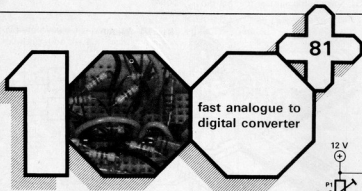

for frequencies up to 500 kHz

The design for a fast analogue to digital converter here clearly shows that this type of circuit does not necessarily have to be complicated. Instead of the usual sawtooth generator + comparator + counter + oscillator, we have used a system in which a fixed reference voltage is fed to a number of comparators. This is known as a parallel converter. The delay normally introduced by the counting process is done away with so the whole process is very fast. The disadvantage of this set-up is the large number of components as each step requires a comparator but, in the three-bit example here, that is not a problem. The reference voltages for the various comparators are generated by means of a series of 1% resistors and a current source based on T1. The conversion factor is set with P1 ($U_{ref} = 1.5 \dots 9$ V). The analogue input voltage is fed via buffer stage IC4 to the inverting inputs of A1...A8. A priority encoder is used for the conversion to binary code. It achieves this by translating the number of the highest comparator activated into a three-bit binary code which appears (inverted) at the output of IC3. With the component values given here the circuit will operate up to about 500 kHz. Apart from the usual applications, this circuit can also be used, for instance, to make unusual effects in a video signal or to convert a black and white picture to colour, when

used with a video combiner. If a PAL or SECAM (TV) signal is applied to the circuit an extra 4.43 MHz notch filter must be added at the input. The circuit can be matched to the normal 75 Ω video cable by connecting an 82 Ω resistor in parallel with R18, with the 4.43 MHz filter between the two resistors.

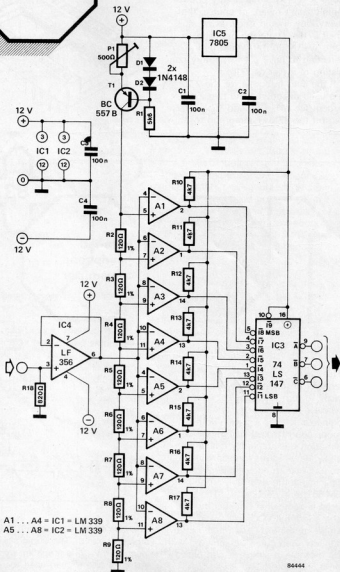

8444



$$2 \times 2716 = 2732$$

4096 bytes in two EPROMs

Almost everybody who builds micro-computer projects will notice sooner or later that he has been stockpiling certain often-used components. A case in point is the 2716 EPROM, which is so commonly used that it is wise always to have a couple on hand. In spite of the fact that the 2716 is so common, EPROMs with double this capacity (2732 = 4096 × 8 bits) are also very popular. This doesn't mean, of course, that everybody should throw away all their 2716s. Quite the opposite, in fact, we thought it would be interesting to have a 4 K memory consisting of a pair of 2716s.

All the lines intended for the 2732 are used directly by the two 2716s except for A11, \overline{CS} , and V_{pp} . Every pin on the 2716s is common to both

ICs with the exception, of course, of \overline{CS} . The enable signals for this pin

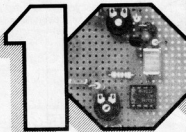
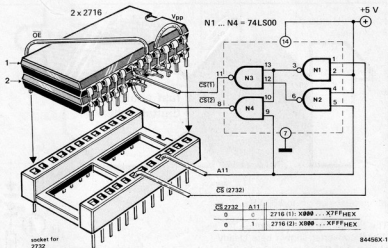

infra-red headphone transmitter

also usable for other audio signals

This circuit is used together with the receiver described elsewhere in this issue to form the simplest infra-red wireless headphone system imaginable. It uses a pulse width modulation (PWM) system which, although unsuitable for critical hi-fi applications, gives a reasonable quality and has an acceptable range. The transmitter is based on an LM 567 tone decoder IC. The layout used is somewhat unusual but the chip's internal VCO and switching stage combine to give much better linearity than could be achieved with, for example, a simple circuit based on a 555 timer IC.

modulate IC1. Pin 6 of the 567 is the trigger input so that the audio signal is superimposed on a HF (about 50 kHz) triangular signal. This causes the rectangular output signal to be pulse width modulated. The remainder of the IC is used as a buffer so that the 567 can drive infra-red LED D1 directly (at a peak current of at least 100 mA) without the need

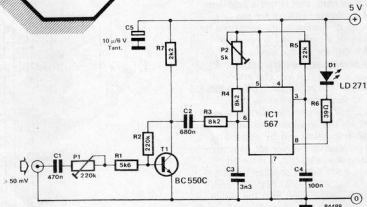

The operation of the circuit is quite straightforward. The audio signal (at least 50 mV_{pp}) is amplified by transistor T1 and is then used to

for any external components. The transmission frequency can be set between about 25 and 40 kHz by means of preset P2.

sync separator

video signal + sync separator = sync signal

This little circuit can separate the synchronization section from the rest

of a video signal. When supplied with a composite video signal of at least 0.5 V_{pp} the circuit outputs quite a respectable (9 V_{pp}) synchronization signal. This is eminently

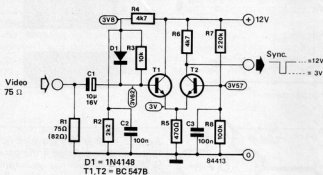

suitable for use with the video effect circuit (video D/A) described elsewhere in this issue.

The basis of the circuit is a comparator consisting of two transistors, the inverting input (T2) of which is connected to a fixed d.c. voltage. When the input signal at the non-inverting input (the base of T1) falls below the voltage set at the base of T2 (about 3.6 V) transistor T1 switches off and T2 conducts. If a video signal is applied to the input the d.c. voltage setting of T1 will be slightly higher than that of T2. On top of this the base setting circuit of T1 contains a clamping diode which will only allow a very small change in the negative direction (roughly 0.4 V). The result of all this is that the video signal at the base of T1 will never fall below about 3.2 V.

This limiting of the lower values means that only a small part of the input signal (provided it is larger than the minimum value) will affect the output signal. In the positive direction T1 simply conducts all the more and T2 remains switched off (the output is then about 12 V). During the sync section, however, T1 will switch off so the sync pulses appear, amplified, at the output.

The current consumption of the circuit is only a few milliamps.

alarm timer . . .

. . . for home and garden

A periodic alarm signal has many applications in daily day life: 'lights off' indicator in cars, water level in-

dicator, alarm clock, memory aid, limit indicator, and calling signal are but a few.

The circuit begins to operate as soon as its input level becomes '0'; after

about 30 seconds the buzzer sounds four times at one-second intervals. This happens every thirty seconds until the input goes logic high again. The circuit is based on a 14-stage CMOS binary counter and oscillator type 4060. The oscillator frequency, f , is determined by $f = 1/2.2R3C1$, where f is in Hz, $R3$ in ohms, and $C1$ in farad.

The oscillator is internally connected to the clock input of the counter. As soon as the reset input (pin 12) is logic low, the counter begins to operate. Because at the onset outputs Q4, Q7, and Q10 are logic '0', pin 12 goes low when the input to N1 is '0'. After about 30 seconds, Q10 becomes '1'. The 1 Hz signal on Q4 is then applied to the base of transistor T1. This transistor therefore conducts in rhythm with the 1 Hz signal and switches the buzzer on and off at the same frequency. After four seconds output Q7 (pin 6) also becomes logic '1'. As both inputs of NAND gate N3 are now logic high, its output becomes '0'. This level ensures that the reset input (pin 12) of IC2 briefly goes high, so that the counter resets all outputs. If the input to the circuit is still '0', the process starts anew; otherwise the alarm stays quiet.

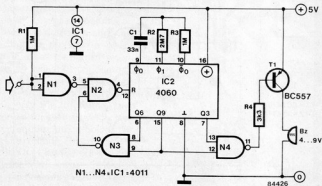

R. Rastetter

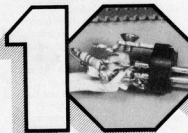

mini signal cleaner

FSK filter for computers

A problem well known to personal computer users is the difficulty of swapping cassette tapes containing software. One of the main reasons for this is the setting of the read/write head in the cassette recorder. This should be at 90° with respect to the tape but in practice this is not always the case, with the result that loading a program from a 'strange' tape causes problems. When using FSK (Frequency Shift

Keying) the signal cleaner here provides a very marked improvement. The time spent searching for the correct signal level is then greatly re-

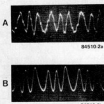
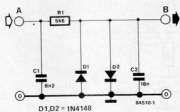

duced. As the filter requires only five components there should be no problem finding a space for it within the case of any computer. The layout of the circuit is not at all complex. The signal passes first through the low-pass filter, consisting of R1 and C2, which has a cut-off frequency of about 1600 Hz. In frequency shift keying a '0' or '1' is recorded on the tape as a sinusoidal signal (with frequencies of 1200 and 2400 Hz respectively) so this filtering removes all the 'rough edges' (figure 2a) from the signal. The result is shown in figure 2b. The two diodes limit the amplitude of the output signal to about ± 600 mV. ■

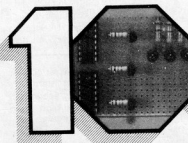

three-state indicator

handy unit for 6502 users

The circuit presented here was designed primarily for 6502 users. It indicates which of the following signals occurred last
 RESET = RES = 0
 INTERRUPT REQUEST = IRQ = 0
 NON-MASKABLE INTERRUPT = NMI = 0
 This information is particularly helpful in the event of failure of a 6502 microprocessor system. It is equally useful during the handling of specific software for such a system. The circuit effectively forms a three-state indicator and consists of three NAND gate latches. Each latch is set by one of the three signals mentioned above. When that happens, the latch in question resets the other two latches via the relevant diodes. At the same time the high Q level causes the relevant transistor to conduct and this in turn makes the appropriate LED light. This LED will remain on until one of the other two latches is set.

An auto reset is also provided but this should be omitted if the particular 6502 system has an automatic reset circuit. In the latter case, it is, of course, the very task of the present circuit to indicate that RES was the last (and first!) of the three signals. If the auto reset is fitted, it will ensure that the LEDs are switched off when the circuit is first switched on. ■

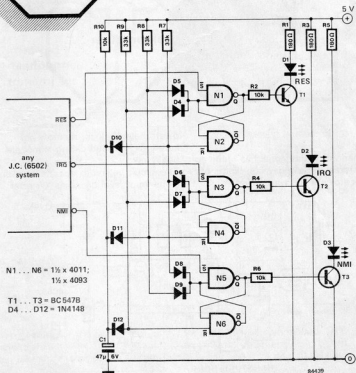

microcomputer power supply protection

overvoltages and short-circuits need no longer be a danger to microcomputers

When the 5 V and/or 12 V part of a computer's power supply breaks down it can mean one of two things: the supply will be either too high or too low (generally zero volts). When the voltage drops the consequences are generally limited to the RAM memory being erased or corrupted.

The 12 V supply is protected in much the same way. When the voltage reaches about 12.7 V thyristor Th2 conducts and shorts the 12 V line to ground. The supply to the coil of the relay is then cut off so Re1 once again falls out. If there is a short-circuit within the computer itself the effect is the same, except, of course, that our circuit does not have to provide the 'short'. When the short-circuit or fault is

found (and cured) the supply can be switched on again by pressing push button S1. An 'off' button has also been provided, which should be of particular interest to ZX users as these computers do not have an on/off switch.

Constructing this circuit is aided by the availability of the printed circuit board shown in figure 2. It is principally intended for use with the microcomputer power supply published elsewhere in this issue and it can be connected directly to that circuit's +5 V and +12 V outputs. If you wish to use this protection with a computer with no 12 V supply line the 12 V section can simply be left out. The relay will then have to be changed so that a 5 V type is used instead of 12 V and it then has to be connected to the 5 V supply line. ■

1

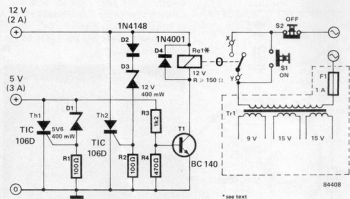

Parts list

Resistors:

R1, R2 = 100 Ω
R3 = 1k2
R4 = 470 Ω

Semiconductors:

D1 = 5V6 400 mW zener
D2 = 1N4148
D3 = 12 V 400 mW zener
D4 = 1N4001
T1 = BC 140
Th1, Th2 = TIC 106

Miscellaneous:

F1 = fuse, 1 A slow blow
Re1 = 12 V relay, e.g. Maplin no. HY20W
S1 = push button, push to make
S2 = push button, push to break

2

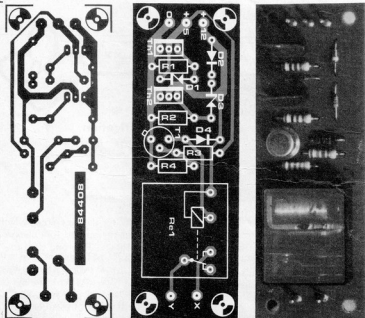

The effects of the voltage rising, due to a faulty voltage regulator, for example, are far more serious. The chances of all the 40,000 to 100,000 transistors in the microprocessor surviving something like that are quite slim. That is more than enough reason to find a place for this supply protection circuit in any computer.

This circuit disconnects the computer's power supply from the mains when its output voltage becomes too high or if it detects a short circuit. If, for example, the voltage on the 5 V line increases for some reason zener diode D1 will start conducting at about 5.6 V. This causes thyristor Th1 to conduct and short the offending supply line to ground. (It is essential for this method of operation that the computer's power supply is current-limited). This causes transistor T1 to switch off with the result that the relay drops out and takes the mains supply with it.

89

three-state TTL logic probe

a small, but useful, TTL test aid

Regular readers of Elektor will know that we often publish various items of test gear. The design shown here is nothing really unusual but it is none the less worth considering because it is very handy. The end product is about the size of a thick felt-tip marker but this marker comes with built-in 'intelligence'.

One of the three LEDs in the circuit will light depending on the voltage

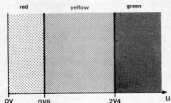

measured at the test point (TP). This voltage is first of all fed to two comparators (A1 and A2). A reference voltage is fed to the other input of each comparator from voltage divider R4/R5/R6. The values chosen give thresholds at 0.8 and 2.4 V as the range between these two levels is a 'forbidden area' for TTL. If the voltage at TP is lower than 0.8 V the output of A2 goes low and causes the red LED (D6) to light. If the measured voltage is higher than 2.4 V the output of A1 will be low so the green LED (D5) will light.

Sometimes, of course, the voltage will be between 0.8 and 2.4 V and then neither the output of A1 nor the output of A2 will be low. When TP is not connected to anything the same thing applies due to the action of R1 and R3. The inverting input of A3 is then pulled high via R9 so the yellow LED (D7) lights.

As we have already suggested, the completed circuit can be made into a very attractive finished product. All the components can be mounted in a line on a narrow piece of Veroboard, as the photo shows, and this can then be slipped into some sort of tube. Ideally this should be transparent to enable the LEDs to shine through.

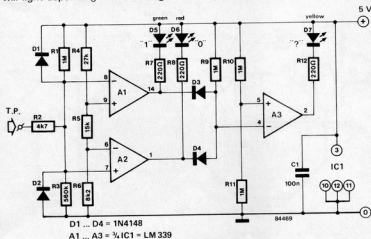
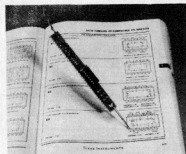

90

amplification selector

scales from 0 to 999

An amplification selector is an accurate measuring instrument that is inserted into a signal path and then allows the gain of that signal to be set precisely between 0 and 999 in unit steps.

Amplifier A1 functions as a (unity

gain) buffer for the test signal which is subsequently applied to a chain of resistors, R8 ... R16, and then to amplifier A4.

Amplifiers A1 ... A3 are connected in cascade. Whereas A1 has unity gain, amplifiers A2 and A3 have a gain of $\times 10$. Each of them is followed by a similar chain of resistors

as A1, R17 ... R25, and R26 ... R34 respectively. From the chains, the signal is also applied to A4. The gain depends on the setting of switches S1 ... S3. You will see from the circuit diagram that the resistor chains, together with R35, are part of the negative-feedback loop of A4. The result is a mixing amplifier with a conversion gain between 0 and 999.

The total resistance of each of the resistor chains is 100 k. If then for instance the three switches are in position 1, the total amplification is $R35/R8 + \dots + R16 = 1$ plus $10R35/R17 + \dots + R25 = 10$ (gain in A2!) plus $100R35/R26 + \dots + R34 = 100$ (gain in A2 + A3!) = 111

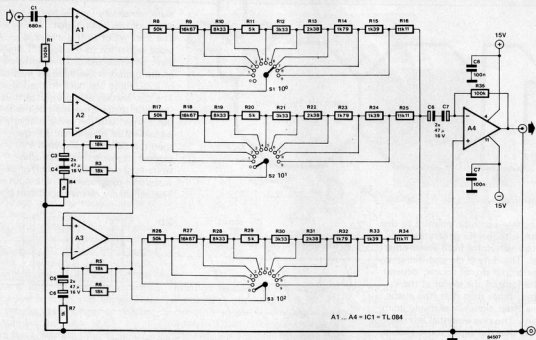

The non-standard-value resistors in the chain may be made up with

aid of another of our 'summer circuits': PARSER

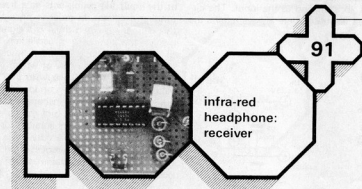

infra-red
headphone:
receiver

for unhampered listening pleasure

This circuit is the receiver to match the transmitter published elsewhere in this issue. Together these two form a very simple, but none the less effective, wireless headphone, or a transmission system for any audio signal.

The signal is transmitted by the infra-red LED in the transmitter. When the receiver reconverts this IR signal into electrical pulses, it will be a rectangular waveform in which the width of the pulses corresponds to the audio information. The signal obtained after amplification and filtering only has to be integrated in order to retrieve the audio information. What could be simpler?

The SL 486 IC is a suitable single-chip receiver for our wireless headphone system as it contains, among other things, a regulated amplifier

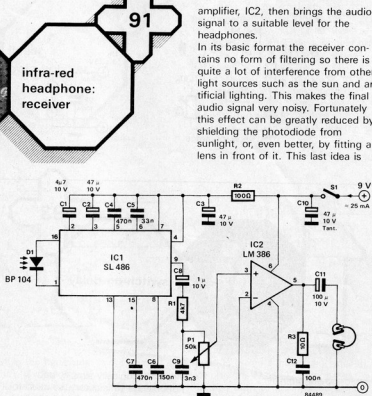

and a filter section. The signal picked up by the infra-red photodiode (such as a BP 104) is fed to the input of IC1, while at the output is the integrator consisting of resistor R1 and capacitor C9. An

amplifier, IC2, then brings the audio signal to a suitable level for the headphones.

In its basic format the receiver contains no form of filtering so there is quite a lot of interference from other light sources such as the sun and artificial lighting. This makes the final audio signal very noisy. Fortunately this effect can be greatly reduced by shielding the photodiode from sunlight, or, even better, by fitting a lens in front of it. This last idea is

particularly interesting as by experimenting with a lens we can increase the range from the original 5...10 metres up to 20...50 metres. That is really quite good for such a simple circuit.

auto duty cycle

for asymmetrical signals

It is quite a common practice to use a schmitt trigger to generate a rectangular waveform from some other signal. The duty cycle and frequency at the output do, of course, depend on the form of the signal at the input but, other than that, the shape of this latter signal is relatively unimportant. The one essential requirement is that the signal must exceed, or at least reach, the triggering threshold of the schmitt trigger. With the circuit shown in figure 1 that is not necessarily so. In order to be able to process smaller signals a.c. coupling may be used and the signal need then only be greater than the hysteresis. The

2a

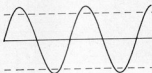

amplitude of asymmetrical signals must, however, be larger than this or the upper or lower threshold may not be reached. The signal in figure 2a will thus produce an output whereas there will be no output if the signal of 2b is applied to the input. The circuit illustrated here always retains the

2b

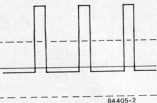

set by means of preset potentiometer P1.

Unfortunately, as in so many things, there is a small cloud wrapped around this circuit's silver lining, namely that when there is no signal at the input the circuit acts as a free-running oscillator. In order to prevent this happening when there is a signal present the frequency of oscillation of R2/C2 must be at least ten times lower than the frequency at which the circuit is used (100 Hz with the values shown). It is then an ideal auto-trigger for an oscilloscope, for example. A disadvantage of the circuit is that it is not very suitable for signals with a very short duty cycle as small amplitude differences then produce broken pulse trains at the output.

1

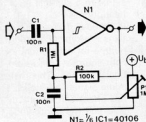

N1 = $\frac{1}{6}$ IC1 = 40106



84405-1

switch-on delay

... for power amplifiers

There is no doubt about the value of a switch-on delay for a power amplifier. We all know the irritating (and potentially damaging) pop heard from the loudspeakers when the power amplifier is switched on or off. The circuit described here pro-

vides a technically simple, but nonetheless satisfactory, solution to this problem. A relay is used to isolate the loudspeakers until the switch-on surge has passed, as this is what causes the loudspeakers to pop. Switching off an amplifier may also cause loudspeakers to pop so this circuit prevents this happening

by switching the 'speakers out of circuit just before this happens. As the diagram shows, we have kept the circuit as simple as possible. Because of this the circuit is both inexpensive and easy to build. One slight disadvantage of this design is that it can only be used with a power amplifier that has a symmetrical power supply (with a maximum of ± 60 V). This is not really such a big problem as most modern power amplifiers have a symmetrical supply.

The operation of the circuit is perfectly straightforward. The a.c. voltage is tapped directly from the amplifier transformer and half-wave rectified by diode D1. The voltage divider resistors, R1 and R2 must have suitable values so that the maximum voltage on C1 is about 5 V higher than the relay voltage. The values given in the diagram are

suitable for a U_b of 45 V and a relay voltage of 24 V. If different specifications are chosen the values of the components must, of course, be suitably adapted. The relay voltage is particularly important as this must be at least 2 V lower than U_b . It should also be remembered that the relay must be able to switch a large current; something in the order of 10 amps is not unusual (depending on the power of the amplifier).

When the power amplifier is switched on, C1 is charged via R1 to about 29 V (in our example). Transistors T1 and T2 follow the capacitor voltage until the zener voltage of D1 is reached ($U_{zener} = U_{relay} + 1.4$ V). The voltage is now sufficient to switch the relay, and with it the loudspeakers. The value of C1 stated ensures a delay of about 5 seconds before this actually occurs, and this is time enough to allow the amplifier to stabilize so no pop is heard. This time can be made longer or shorter by changing the value of C1.

When the power amplifier is switched off the same thing happens, in principle, but in the opposite order and

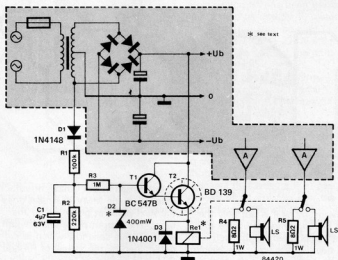

much more quickly. The voltage drops as C1 discharges via R2. The circuit is 'tuned' so that the voltage across C1 falls quite quickly below the relay voltage and the relay then drops out. The loudspeakers are then certain to be switched out of circuit

before the pop should be heard. Finally it should be noted that even with good cooling T2 must never dissipate more than 5 W ($P = I_{RE} \times (U_b - U_{RE})$).

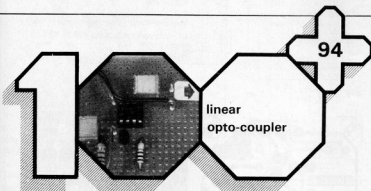

The MOC 5010 opto-coupler may be used to isolate a circuit from the mains, as audio interface, in medical electronics, and in many other applications.

Because of its high isolation resistance (10^{11} ohms), the MOC 5010 is eminently suitable for applications where a circuit is connected directly to the mains, as, for instance, in most TV receivers. It can therefore be used to give enhanced performance to the 'TV sound interface' described in the April 1982 issue of *Elektr* U.K. With a bandwidth stretching from 5 Hz to well over 100 kHz, there is no need to worry about the audio response as there was in earlier opto-couplers.

Basically, the MOC 5010 converts a variation in input current into a variation of output voltage. Input voltages are first transformed into currents. The circuit shown in figure 1 has an amplification factor of about 0.75. Its input should not exceed 2 V RMS,

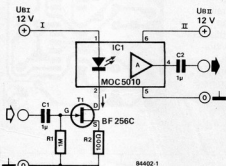

while the bandwidth is 118 kHz at the -3 dB points.

Field-effect transistor T1 functions as a voltage/current converter: its slope is about $3 \dots 4$ mA/V. The quiescent drain-source current is about 10 mA. Amplifier A has a transfer resistance of around 200 mV/mA so that the total gain is of the order of

$0.6 \dots 0.8$ ($-4.5 \dots -2.0$ dB).

The output impedance of the amplifier is not greater than 200 ohms. An external amplifier may be connected to pin 4 of the IC. When the input voltages lie above 2 V RMS, a potentiometer should be used as a voltage divider as shown in figure 2.

If the overall gain is too small, a transistor should be used instead of the FET (also with 10 mA quiescent current), but the circuit then virtually reverts to that published in *Elektr* U.K. in April 1982!

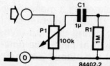

It is important to note that two separate power supplies are required: not only the two $+12$ V terminals, but also the two '0' lines must be kept isolated from one another! In many cases it should be possible to obtain the $+12$ V for the transmitting end of the circuit from the TV set: this is, of course, easily found out if you have the service manual or even a circuit diagram of the set.

100



flashing telephone light

95

see the phone ringing

In many instances it is not only the hard of hearing who are unable to hear the telephone ringing: even with normal hearing it is often impossible to detect above the noise from the vacuum cleaner or the radio. The present circuit enables the ringing of the phone to be seen with the aid of a flashing lamp. It is perfectly feasible to put a number of lamps in parallel and place them in different locations.

Inductor L1 is attached to the telephone by a suction pad: it may be necessary to try out several positions on the telephone to obtain best results.

A reference voltage of about 4.8 V is provided by potential divider R1/R2 and applied to the non-inverting input of opamp IC1 directly and to the inverting input via L1/P1. The preset is adjusted to give equal levels of direct voltage at both inputs of the opamp: the output of IC1 is then logic low.

When the telephone rings, an alternating voltage is induced in L1, causing the potential at the non-inverting input of IC1 periodically to exceed that at the inverting input. This results in a rectangular pulse train at the output of the opamp. The trailing edges of these pulses trigger one half of IC2 via C8. This half of the IC operates as a monostable multivibrator (MMV), the output of which is low during time-out. When a pulse arrives at pin 6, the timer is triggered and the output (pin 5) goes high, as long as the output is high, subse-

quent pulses at pin 6 have no effect: only when the MMV has reset does the next pulse at pin 6 trigger the timer. The output pulse has a width of about five seconds, which is determined by the values of R4 and C3.

The second half of IC2 functions as an astable multivibrator producing

rectangular pulse trains when its reset input (pin 10) is high, which is as long as the MMV is triggered. The pulse repetition frequency is determined by the values of R5, R6, and C6. The output signal on pin 9 of the AMV switches relay Re on and off. As the pulse spacing is just about one second, the relay, and therefore the lamp(s) connected to it, is switched on and off five times. The quiescent current consumption of the circuit is about 10 mA at 6 V. In selecting the relay, its operating voltage as well as the power rating of the lamps should be taken into account.

The printed-circuit board for this circuit is not available ready-etched; it may, however, be produced with the aid of the track layout diagram (no. 84407) given in the PC board pages at the centre of this issue.

Parts list

Resistors:

- R1 = 15 k
- R2 = 10 k
- R3, R5, R6 = 100 k
- R4 = 470 k
- P1 = 1 M preset

Capacitors:

- C1 = 1 μ /16 V
- C2, C3, C5 = 10 μ /16 V
- C4, C7, C8 = 10 n
- C6 = 4 μ /7/16 V

Semiconductors:

- D1, D2 = 1N4148
- IC1 = 741
- IC2 = 556

Miscellaneous:

- L1 = telephone pick-up coil with suction pad
- Re = relay, see text

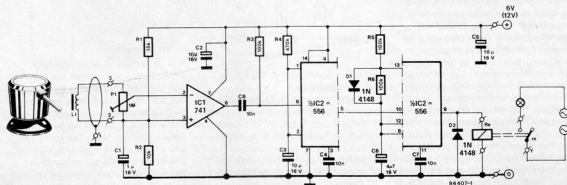
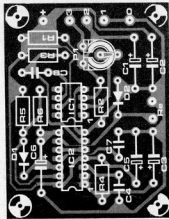
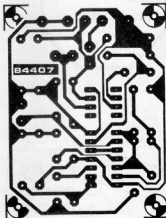

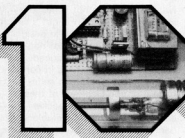

EPROM eraser

reset switch S1 has been pressed: this should be exactly 10 minutes. Note that the relay contact must be rated for switching 220 V a.c.! The relay itself may be of the pc board type.

The mains power supply may be any well-regulated type giving 6 V d.c. The current consumption without the relay is about 5 mA.

Using the eraser is fairly easy: lay the EPROM on a flat surface and place the case over it after having set S3 to the required erase time (10, 20, or 40 minutes). Lighting of the red LED indicates that erasure is in progress. A push on S1 ensures that the correct erasure time will be run through: this is necessary as the counter begins to count as soon as the supply voltage is switched on.

with radiation counter

All that's required to erase an EPROM is basically an ultraviolet (UV) lamp which radiates the EPROM window at the right distance (about 2...3 cm) for a period which depends on the manufacturer (normally 10...40 minutes). As we don't think you'll want to sit around

Re1 then ceases to operate and switches off the UV lamp. This is absolutely necessary as ultraviolet light is extremely harmful to your eyes. The clock frequency may be set by means of P1 in two ways: (1) with the aid of an oscilloscope or frequency counter to 6.85 Hz, or (2) by measuring the time taken for output Q12 of IC2 to become logic 1 after

1

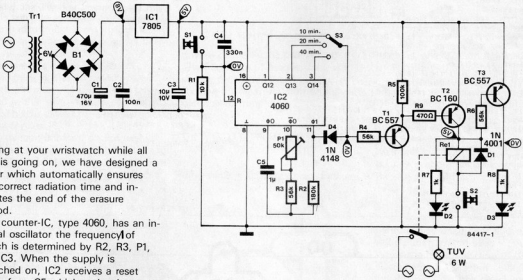

gazing at your wristwatch while all this is going on, we have designed a timer which automatically ensures the correct radiation time and indicates the end of the erasure period.

The counter-IC, type 4060, has an integral oscillator the frequency of which is determined by R2, R3, P1, and C3. When the supply is switched on, IC2 receives a reset pulse from C5 which makes it start counting. Outputs Q12...Q14 are logic low, and T1 and T2 conduct. When S2 is closed (see below), relay Rel1 is actuated and the UV lamp is switched on. In addition, red LED D2 lights. The base of T3 is connected to the positive supply line via T2 so that T3 is cut off. After the time set by S3 has lapsed, the relevant output of IC2 goes high. Transistors T1 and T2 are then cut off, the relay switches off the UV lamp, and LED D2 extinguishes. The base of T3 is then connected to earth via the relay coil and S2: transistor T3 conducts and green LED D3 lights to indicate the completion of erasure.

A tip: fit the UV lamp in a suitable case with open underside as shown in figure 2. Push-button S2 should be mounted in a way which ensures that it closes when the case is laid flat on an even surface, but opens as soon as the unit is lifted; the relay

2

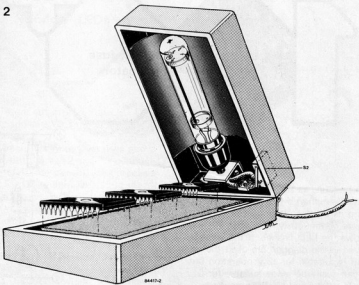

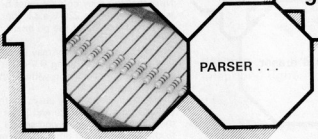

a useful design aid

No, the title does not relate to a help in grammar; PARSER is not a circuit either, but rather an aid in designing one. It often happens that non-standard resistors are required. The normal solution then lies in connecting standard resistors in series or parallel or combinations of these. The computation on a pocket calculator to arrive at suitable standard values can be quite a long one, even if the actual tolerances of the various resistors are well within their nominal values. With PARSER it becomes almost a routine operation that does not take very long, provided you have a BASIC microcomputer available. As you may have guessed by now, PARSER is a small BASIC program for the determination of innumerable combinations of resistors within a given tolerance in a very short time. When you have worked out some examples other than the one given with the program, you will see what we mean.

```

10 REM PROGRAM TO CALCULATE PARALLEL AND SERIAL RESISTORS
20 DATA 1,1.2,1.5,1.8,2.2,2.7,3.3,3.9,4.7,5.6,6.8,8.2
30 DIM R(12):FOR A=1 TO 12:READ R(A):NEXT A
40 FOR Q=1 TO 36:PRINT " ":NEXT Q:PRINT:PRINT
50 X=1:Y=1:INPUT "RESISTANCE":R
60 IF R<.5 OR R>16400000 THEN PRINT "OUT OF RANGE":GOTO 40
70 INPUT "TOLERANCE IN %":T
80 L=R-(T/100)*R:U=R+(T/100)*R
90 PRINT "FROM":L:"TO":U:"OHMS":PRINT
100 PRINT "PARALLEL R'S":A#="!"
110 FOR Z=1 TO 7
120 FOR M=1 TO 12:IF R(M)*X<2KU OR R(M)*X<R THEN 1090
130 FOR W=1 TO 7
140 FOR N=1 TO 12:IF R(N)*Y<R THEN 1080
150 P=R(N)*X*(R(N)*Y)/((R(M)*X)+(R(N)*Y))
160 GOTO 1080
170 X=1:Y=1
180 PRINT "SERIAL R'S":A#=" "
190 FOR Z=7 TO 1 STEP -1
200 FOR M=12 TO 1 STEP -1:IF R(M)*X<L/2 OR R(M)*X<R THEN 1090
210 FOR W=7 TO 1 STEP -1
220 FOR N=12 TO 1 STEP -1:IF R(N)*Y<R THEN 1080
230 P=R(M)*X+R(N)*Y
1000 IF P<L OR P>U THEN 1080
1010 T1=(100*(P-R)/(100)*1000):T1=INT(T1)/1000
1020 R1=R(M)*X:K1#="":K1#=" "
1030 IF X<100 THEN R1=R1/1000:K1#="K"
1040 IF X<100000 THEN R1=R1/1000:K1#="M"
1050 R2=R(N)*Y:IF Y<100 THEN R2=R2/1000:K1#="K"
1060 IF Y<100000 THEN R2=R2/1000:K1#="M"
1070 PRINT R1:K1:TAB(7):A#:R2:K1:TAB(14):"=":P:TAB(29):T1:"%"
1080 NEXT N:Y=Y*10:NEXT W:Y=1
1090 NEXT M:X=X*10
1100 NEXT Z
1110 IF A#="!" THEN 170
1120 PRINT
1130 INPUT "OTHERS=Y?":H#
1140 IF H#="Y" THEN 40
1150 END
    
```

OK
RUN

```

.....
RESISTANCE? 16000
TOLERANCE IN %? 1
FROM 15840 TO 16160 OHMS

PARALLEL R'S
10 K !! 150 K= 16071.4286 .446 %
27 K !! 39 K= 15954.5455 -.285 %
SERIAL R'S
15 K + 1 K = 16000 0 %
12 K + 3.9 K= 15900 -.625 %

OTHERS=Y? N
    
```

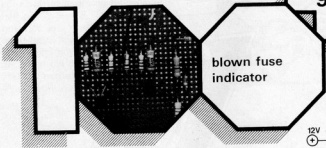

ling the values of all the resistors. The indicator consists of an astable multivibrator (T1 and T2) and a LED driver stage (T3). The whole circuit, with the exception of R5, is connected before the fuse in the supply. The output of the multivibrator, which is always active as long as the supply is present, is connected, via D2, to the input of the LED driver stage (the base of T3). As long as

for low voltage circuits

This circuit, as the name suggests, indicates when a fuse has blown. As long as the fuse is good the LED lights continuously, but when it blows the LED flashes. If the values given in the diagram are used the circuit is suitable for 12 V operation but it can easily be made suitable for 6 or 24 V by simply halving or doub-

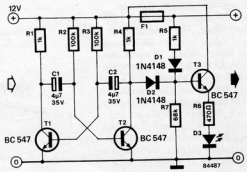

the fuse is good (not blown) the base current for T3 is always provided via R5 and D1, with the result that the LED lights continuously. When the fuse blows the base current is only provided by the AMV

and, as this is not continuous, the LED flashes. The current consumption of the circuit is about 30 mA, most of which is due to the LED. If the indicator is fitted to some battery-powered cir-

cuit it is worth while to use a high-efficiency LED for D3 and to change the value of R6 to suit the lower LED current.

E. Neefjes

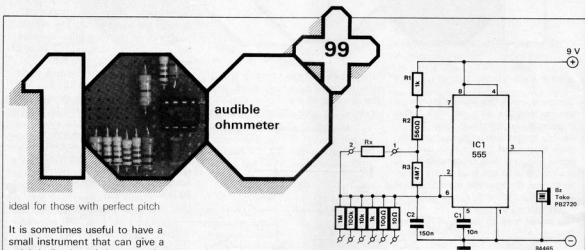

ideal for those with perfect pitch

It is sometimes useful to have a small instrument that can give a quick indication of the approximate value of a resistor.

The present circuit enables an unknown resistor to be compared with a number of known resistors and in that way indicate between which two values the unknown resistor lies.

The circuit is based on the well-known 555 which is connected as an oscillator (astable multivibrator). The output of the oscillator is used to

drive a piezo electric buzzer. The frequency of the oscillator is inversely proportional to the value of Rx (the unknown resistor) and is determined from

$$f = \frac{1}{\ln 2 \left[R1 + 2(R2 + \frac{R3R_x}{R3 + R_x}) \right] C2} \text{ Hz}$$

where $\ln 2 = 0.6931$, all resistors are

in ohms, and C2 is in farads. By substituting one or two of the known resistors for Rx, the note emitted by the buzzer should give a fair indication of the approximate value of Rx. Of course, if you have perfect pitch, you do not need the known resistors... In that case, we'll tell you that if Rx = 0, the frequency is about 4500 Hz, while when Rx = ∞, it is 2 Hz.

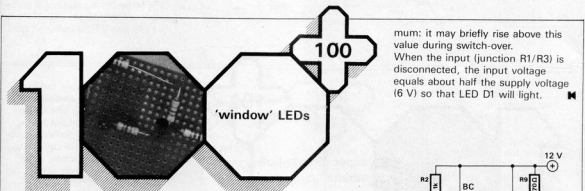

easy-to-make reference circuit

It is often interesting (if not required) to know whether an amplifier is going into saturation, or whether certain limiting values (thermometer, power supply, etc.) are being exceeded. It is, however, not always feasible to use a fully-fledged window discriminator and in those cases the circuit presented may be of interest.

When the level of the input voltage lies between 3.5 V and 8.5 V, transistors T1 and T2 conduct (T3 and

T4 are cut off) so that LED D1 lights to indicate that the input signal is 'in range'.

When the input level rises above about 8.5 V, T2 and T3 conduct (T1 and T4 are cut off) which causes LED D2 to light indicating that the input level is 'above range'. Finally, when the input signal drops below about 3.5 V, T1 and T4 conduct so that LED D3 lights indicating that the input is 'below range'.

The current consumption is for all practical purposes governed by the LED currents which are 20 mA maxi-

mum: it may briefly rise above this value during switch-over. When the input (junction R1/R3) is disconnected, the input voltage equals about half the supply voltage (6 V) so that LED D1 will light.

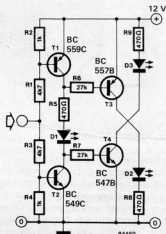

101

scratch and
rumble filter

audio extremes filter

The purpose of this filter is to attenuate very low and very high audio frequencies as signals in these frequency ranges generally do more harm than good for the total audio signal. Another way of considering this circuit is to see it as a very wide band-pass filter for the band containing the most important part of the audio spectrum.

The layout is quite simple as it con-

sists of two filters in series, a low-reject followed by a high-reject. Each filter consists of a pair of cascaded second-order filter stages to achieve

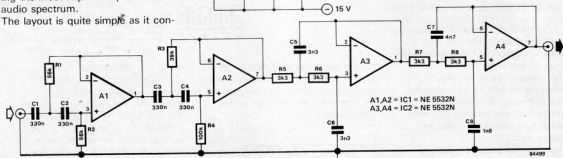
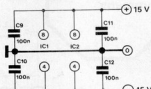

a very steep characteristic of 24 dB/octave. The cut-off frequencies are at 11.8 Hz and 10.7 kHz with the component values given here. The suitability of these points depends on the application and it is not at all difficult to change them. The 11.8 Hz can be increased by reducing the value of capacitors C1 . . . C4, or it can be lowered by increasing the capacitance. These capacitors must all have the same value. The cut-off frequency of the high filter can also be modified by changing the value of resistors R5 . . . R8. Like the capacitors, these four resistors must all have the same value but this value can be reduced to increase the cut-off frequency or raised to lower the frequency.

The op-amps used are a low-noise type and there are two in each IC package. Two ICs are therefore required for each channel. Current consumption per channel is about 20 mA.

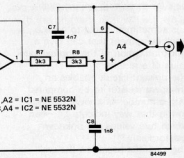

102

super simple bell
extension

hear the telephone ringing where
you are, not where **it** is

This has got to be one of the simplest electronic bell extension circuits ever designed. In all it contains just seven components and none of them are even slightly unusual. They are the kind of parts that most electronic hobbyists will probably have

lying around somewhere, and these seven components are all that are needed to make a universal telephone bell extension circuit. The telephone bell operates on an a.c. voltage so this must be rectified by the four 1N4148 diodes in order to make it suitable for the d.c. buzzer. Obviously, the voltage across the buzzer cannot be allowed to rise too

high so a resistor is connected in series with the rectifier and a zener diode across the buzzer. The values used give a voltage of about 5 V across the buzzer, but, depending on the type selected, this can quite easily be changed. Furthermore, if the input voltage is more than about 10 V a.c. the value of the series resistor will have to be increased according to Ohm's law ($U = R \cdot I$). Take care not to exceed the buzzer's maximum permitted current.

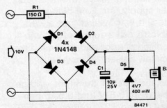

103

6502 bootstrap

a CPU detour

During its initialization procedure, the 6502 processor starts by getting the start vector which is located at addresses \$FFFC and \$FFFD in ROM. This is a fixed instruction that cannot be changed, and it points to a memory zone in PROM, which, in most computers, is very difficult for the user to access. The circuit described here makes it easy to reroute the 6502 to a start address chosen by the user: \$XFFC/\$XFFD where X is any hexadecimal value. At this address the CPU will find the appropriate vector pointing to the start routine written by the user (in EPROM) instead of the standard routine written by the manufacturer. The only hardware change required to achieve this is to connect the circuit shown between the 6502 and its bus. Now every time the CPU emits an address between \$FFFB and \$FFFF (the address decoding is a little less precise than is necessary for only re-routing the processor when it outputs addresses \$FFFC and \$FFFD), the bus receives an address between \$XFFB and \$XFFF,

where X is determined by the user by means of four switches (or four wire links). If S4, for instance, is switched to +5 V A15' is equal to A15, but if the other position is selected A15' = $\bar{A}15$. To use this circuit, lines A3 . . . A15 on the bus must be fed to N1 and the link be-

tween outputs A12 . . . A15 of the 6502 and the system bus must be broken. These lines are then connected to lines A12' . . . A15' of the detour circuit. Each of lines A12 . . . A15 is connected to one of the inputs of AND gates N2 . . . N5. The second input to each of these gates is fed by the logic level set by the user with the switches. The resultant binary word constitutes the hexadecimal value of X in the destination addresses \$XFFC and \$XFFD. In most cases this memory zone will be found in an EPROM which, apart from the RESET vector, will probably also contain the initialization routine. Remember, of course, that the change described here also implies that the IRQ and NMI vectors (\$XFE/\$XFF and \$XFA/\$XFB respectively) and the corresponding routines be modified accordingly. ■

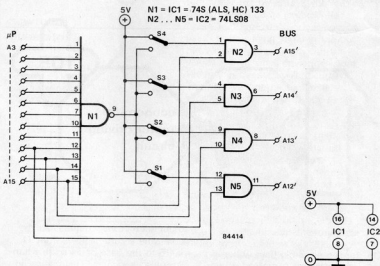

104

coffee temperature indicator

'Some like it hot'

You've just finished a hard day's work and are heading home, looking forward to a relaxing evening. Sitting in your favourite chair while your faithful dog brings your slippers and paper. The crowning glory is, of course, the cup of hot coffee . . . But sometimes it doesn't work quite like that! The dog has to be pried

out of what is also his favourite chair, and it takes almost all your effort to coax him, grumbling and growling, to reluctantly fetch your slippers and paper. You put on the slippers and your feet begin to feel decidedly damp, the rain has made the ink in the paper run, and then to top it all the coffee is too cold. Before you chuck in the towel . . . read on; we may not be much good

at canine psychology, but we do have some ideas about coffee. These is little dispute that the best temperature for coffee is at least 80 degrees Celcius. That is the temperature where your tongue just begins to . . . but let's not go into that here. Because coffee has also become a common prescription for the ailment known as 'Monday-morning', we decided that it would be better to remove all traces of guesswork from this question of 'how hot is it?'. As the diagram shows, there is not very much involved in this circuit. A voltage regulator, a temperature to voltage converter, a comparator, a couple of transistors and LEDs, and a handful of resistors and capacitors, is the total component count. The operation is also straightforward. If the coffee is at less than the correct temperature the output of IC3 is low, keeping T1 switched off. The other transistor, T2, therefore conducts and

the red LED lights to show that the coffee is too cold. As soon as the temperature is high enough (above 80°C), the green LED lights.

What actually happens is this: The temperature, which is measured by IC2, is converted to a voltage. The idea is that the LM35 should hang in the coffee, so the three connections to the IC must be isolated. This can be done by fixing the temperature sensor in an old ballpoint pen, or by sealing it with some non-poisonous two-component glue or in some heat-shrinkable tubing.

The output voltage of IC2 increases by 10 mV for every degree Celsius rise in temperature. The reference voltage at the inverting input of IC3 must be set to 800 mV with P1. As soon as the voltage on the non-inverting input also reaches 800 mV, the output of the comparator switches to high. This causes T1 to

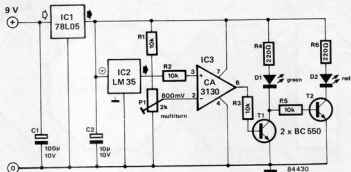

LM35

conduct, switching T2 and the red LED off. The green LED will now light to show that the coffee is up to the right temperature. Incidentally a clever handyman could probably adapt this circuit so that it also indicates if the dog is in a good or a bad mood!

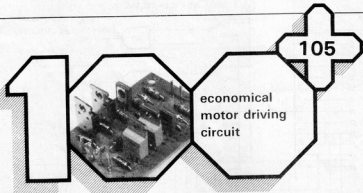

Parts list

Resistors:
R1 ... R4 = 120 Ω
R5 ... R8 = 27k

Semiconductors:
D1 ... D4 = 1N4001
D5, D6 = 1N4148
T1, T3 = BD 242
T2, T4 = BD 241
T5, T6 = BD 140/BD 136

saves components and energy

Oh, for the good old days, when if you wanted to run a motor for two minutes you switched on the power for two minutes. Now we have computer-controlled robot arms, electronic mice, and all manner of technological advances. For all this, however, many people still shy away from the idea of something like a motor-driving circuit. As the drawing here shows, such a circuit is quite straightforward, especially as we have even gone so far as to design a printed circuit board for it.

The circuit has two inputs and if both are '1' (+12 V) nothing happens. As soon as the voltage on one of the inputs, A, for example, becomes zero driver transistor T5 conducts. This causes both T1 and T4 to conduct and the motor turns in a particular direction. This brings us to the stage where we must explain why the circuit is 'economical'. It will not have escaped your notice that each pair of transistors in the bridge is controlled by a single driver transistor. This not only saves components, but also saves the energy that would otherwise be used by two driver transistors. When T5 is made

to conduct T1 will conduct. At the same time a current flows from T1 via T5 to the base of T4 so this transistor also conducts. This means, in effect, that we are using the base current of T1 and T3 to drive T4 and T2 respectively, giving us a common driving circuit.

There are two other components that merit a few lines of explanation, namely D5 and D6. These ensure that nothing untoward happens if both inputs are earthed at the same time. If, for example, input A is at zero volts both T1 and T4 conduct and the anode of D6 is connected to the +12 V line. If input B is now earthed T6 (as well as T2 and T3) cannot conduct because its base is kept positive. Input B can only be activated, therefore, after the voltage at A goes high, and *vice versa*. Pulse-width modulation could be used to control the speed of the motor. What this means is that the signal fed to input A or B is not continuous but a string of pulses whose width can be varied. The narrower the pulses are the faster the motor turns.

If heavier motors are to be driven T1 ... T4 may be replaced by darlingtons that are rated high enough

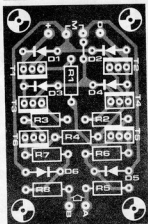
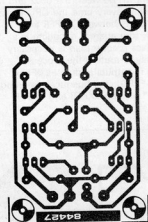

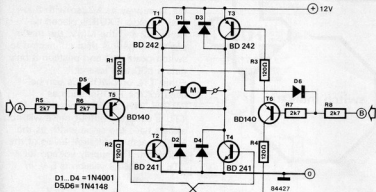

to handle the expected current. The inputs to this circuit are intentionally 'active low' to enable it to be easily driven by TTL logic. The outputs of TTL gates can switch a few milliamps to earth but can supply very little current themselves, certainly not enough to drive a transistor. If the supply for the motor is greater than 5 V the TTL gates must have open-collector outputs. The maximum current that the motor can draw is about 1 amp and the quiescent current consumption is almost nil.

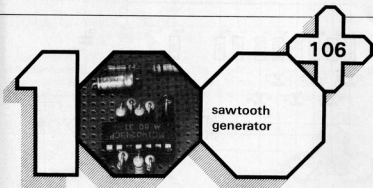

from rectangle to triangle

Sawtooth generators are required in electronics for many purposes. Typical examples are found in music electronics where the rectangular output of a single octave divider must be converted into a sawtooth-shaped signal, or in measurement technology to provide the control signal for an analogue-to-digital converter.

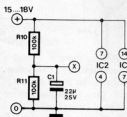

cessive Q output of IC1. For instance, the amplification of output Q2 is two times that of Q1. Since the frequency is halved at each successive Q output, this means that the higher the pulse rate, the lower the amplification as is shown in figure 1. If high stability resistors are used, the resulting steps in the output will be symmetrical; with the values shown small deviations from linearity in the step will occur. The time/voltage characteristics show clearly how the stepped waveform is built up. For convenience's sake, the inversion in the opamp has been ignored: what is important here is the mathematical relation between the various waveforms. In reality, the stepped waveform would be a descending rather than an ascending one. Where an ascending waveform is required, a second opamp with unity gain should be connected to the output. The output waveform has 256 steps; this number may be halved by omit-

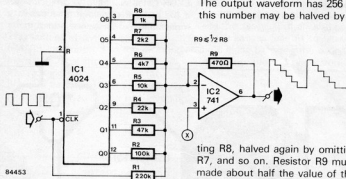
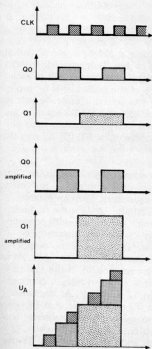

In spite of its modest configuration, the circuit provides a perfectly usable output signal. The (external) clock pulse are applied to a 7-stage binary counter, a CMOS type 4024 IC. The output signals of the IC, Q0...Q6, are together with the clock signal applied to an opamp which has been connected as a summing integrator. Resistors R1...R8 are so arranged that the value of each is half that of the preceding one. In other words, $R2 = \frac{1}{2}R1$, $R5 = \frac{1}{2}R4$, and so on. The effect of this is that the gain of the opamp doubles for each suc-

ting R8, halved again by omitting R7, and so on. Resistor R9 must be made about half the value of the last resistor used, as otherwise the height of the output signal will be halved. The fundamental frequency of the sawtooth signal is the same as that of the finally used output of the IC. The clock signal should have a frequency 256 times the required output frequency. If fewer divider stages are used, the clock frequency may be halved (compound!) for each omitted stage. The height of the clock pulses at Q0...Q6 should preferably be the same to prevent asymmetry of the stepped waveform. Power requirements are 15...18 V with a current consumption of about 12 mA.

107

switch indicator

one pulse per switch position

It is sometimes necessary to generate a pulse as soon as a mechanical switch is operated. The circuit proposed here does just that and only needs a small number of components. Furthermore it can easily be expanded for more contacts. The circuit diagram shows the layout for a six-way switch. An important feature of the circuit is that it works with both make-before-break and break-before-make switches. A couple of EXOR gates (N1 and N2) are used to detect when switching takes place; N1 handles positions 1 . . . 4 and N2 takes care of positions 5 and 6. A number of LEDs (D1 . . . D6) indicate the switch position selected. Every time the position is switched the level at the output of N2 changes, thereby triggering the monostable multivibrator consisting of N3, R1 and C1. With the values stated, this causes a 200 μ s pulse to be output at pin 8 of N3.

When building this circuit it must be remembered that the inputs of N1 and N2 have pull-up resistors

(R2 . . . R4) so there is always a defined level present. The value of the resistor is not at all critical. The LEDs with their resistors may be left out if a visual indication of the switch position is not desired. Extra EXOR gates will have to be included if the number of switch positions is more than six. These are added in

the same way as N2 (so with 8 inputs an extra EXOR is placed between N2 and the MMV, the free input to the gate is then connected to switch position 7 and position 8 only gets a LED and resistor). Either TTL or CMOS ICs can be used for the EXORs, such as 74LS86, 74HC86, 4030, or 4070. If TTL is used the output pulse will not always have the same width as the MMV reacts at different levels of the waveform. The supply voltage for a TTL or HCMOS version is 5 V, in

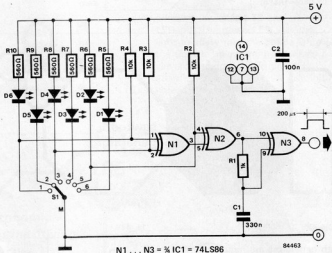

other cases 3 . . . 15 V is permissible. The length of the output pulse may be changed by using different values for R1 and/or C1. If CMOS ICs are used the value of R1 can be as high as a few megaohms. The current consumption with CMOS is 10 mA, with TTL this rises to 20 mA.

108

transistor polarity tester

n-p-n or p-n-p?

Transistor testers are nothing new in Elektor: almost every year sees at least one new one. There are, however, not too many which can independently differentiate between n-p-n and p-n-p types. True, the making of such a distinction is not often called for, even though in

many a component drawer the two types are thoroughly mixed up. Normally, the data sheet or a list of comparative types quickly gives the answer. If these, however, are not available or there are other reasons why this method cannot be used, the tester described here will prove very useful. Operation is very simple: the test

transistor is placed in the socket and push-button S1 is pressed. If the transistor pins correspond to pins B-C-E of the socket, it is an n-p-n transistor which is optically indicated by LED D1. If LED D2 lights, it indicates that the transistor pins correspond to pins (B)-(C)-(E) and that therefore the transistor is a p-n-p type.

How does it work? Transistors T1 and T2, together with associated resistors and capacitors, form an astable multivibrator (AMV), the frequency of which can be set with potentiometer P1. The test transistor is connected to one of the outputs (collector of T2) of the AMV via protection resistor R6. If the test transistor is an n-p-n type, it conducts when T2 is cut off. At the same time, T3 conducts so that D1 lights. If, however, the test transistor is a p-n-p type, it conducts when T2 does, and this cuts off T3. As the

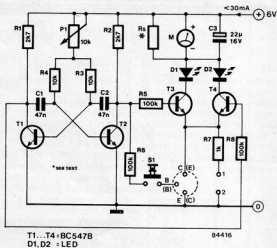

collector potential of T1 is then high, T4 conducts and D2 lights. Terminals 1 and 2 have been added

as an aside and may, for instance, be used to test the continuity of conductors. This is possible, because

when the terminals are short-circuited both LEDs light. The terminals may also be used to determine the anode and cathode of a diode: the LEDs remain extinguished when the cathode is connected to 1, but light with the anode at this terminal.

Meter M indicates the current flowing through the test transistor: capacitor C3 smooths the rectangular pulses from the AMV. If you do not want this metering circuit, simply connect the anodes of the LEDs to the positive supply line via $R_s = 330 \Omega$.

The supply voltage should be not higher than 6 V to prevent the emitter-base reverse potential exceeding the maximum permissible level of 6 V should the emitter and base connections be accidentally reversed.

G. Gerhardt

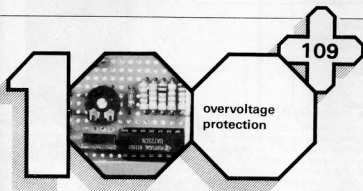

for use with most power supplies

Although the circuit described uses an SCR (silicon-controlled rectifier) as protection device, it does not depend on direct crowbar action: instead the SCR causes a fuse to blow.

A 723 voltage regulator, used as

locked comparator and SCR driver, provides an internally generated reference voltage of 7.15 V at pin 6. This voltage is divided by two (R_4/R_5) and applied to the inverting input (pin 4) of the comparator. The voltage to be protected (at point A) is divided in R_1, P_1 and R_2 and then applied to the non-inverting

input of the comparator (pin 5). The trigger level may be set between 4.5 . . . 17 V with P_1 .

Points B, C, and D are all connected to the unregulated power supply line. Note that the voltage at pin 12 of the 723 should not be less than 9.5 V. If the unregulated line is lower than this value, pin 12 (point B) must be connected to an auxiliary voltage of not less than 9.5 V.

When the voltage at point A exceeds a value predetermined by P_1 , pins 9 and 10 of the 723 become logic high and the SCR (a type TIC 106 or equivalent) fires. This creates a virtual short-circuit between the positive terminal of C1 and earth which causes fuse F1 to blow. The time lapse between the overvoltage occurring and the trip action is 1 . . . 2 μs .

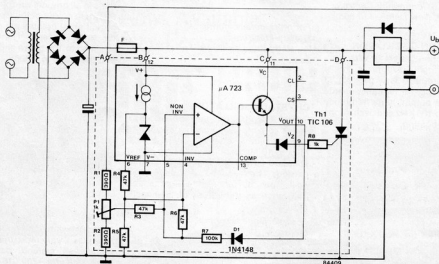

TERMINAL STRIPS

Instrument control devices have single station terminal strips which can be mounted side by side or in front of each other with top covers to prevent accidental touch and to enable markings. The strips, mounted on insulated panel can take conductors upto 18 swg and are rated for 5 amps.



For further information contact:
Instrument Control Devices,
14, Manorama Niwas, Datar Colony,
Bhandup, Bombay—400 078.

TV COMPONENTS

For colour television sets, MG Electronics are manufacturing EHT transformers, width coil, linearity coil and driver transformer. The company claims leadership in the manufacture of deflection components too.



For further information, write to:
MG Electronics Pvt. Ltd.,
Twiga House, 3-Community Centre,
East of Kailash, New Delhi—110 065.

MULTIFUNCTION OSCILLATOR

VFO 13, a function generator with sine, square and triangle wave forms, incorporating IC circuitry, is a product of Vasavi Electronics. Its features include pure sine wave output, large frequency range of 1 Hz to 100 KHz and oscillations without motor boating.



For details, contact:
Vasavi Electronics,
162, Vasavi Nagar,
Secunderabad—500 003.

MICA PARTS

Mica, one of the best known electrical insulating materials, is dished out in various shapes, sizes and formats. Semiconductor mounting mica washer, mica insulators for trimmers, flashers, regulators, starters and transmission equipment, mica gasket for boiler gauge glass picking, mica powder and flakes and micanite products are some of them.

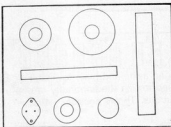

write to:
B.R. Enterprises,
91, Netaji Subhas Road,
Calcutta—700 001.

IC POWER SUPPLIES

Omega Electronics offer a wide range of IC regulated power supplies having variable, dual, dual tracking, triple and fixed outputs. Functioning either in constant current or constant voltage mode, the output voltages range from zero to 60V. An additional feature is automatic crossover for overload and short circuit protection.



For more details, contact:
Omega Electronics,
36, Hathi Babu ka Bagh,
Jaipur—302 006.

CRYSTAL OSCILLATOR

Statek Corporation has announced a series of surface-mountable oscillators using miniature quartz crystals, from 2 MHz to 10 MHz and the package is in a standard 24-pin leadless, ceramic chip carriers. The manufacturers claim small size, low current and high shock resistance as the virtues of their oscillators.

For information, contact:
Electronic Devices,
14, Hanuman Terrace,
Tara Temple Lane, Lamington Road,
Bombay—400 007.

WELDING RECTIFIER

A fully-electronically controlled, thyristorised, welding rectifier with dual function has been developed by Advani-Oerlikon. Known as Ador Thyroarc, the rectifier functions on three phase power source and the current is infinitely variable from 20 to 500 A. Rugged and housed on sheet steel, the rectifier is protected against water drips, splashes and overheating. It is ideally suited for manual welding using stick electrodes, claim the manufacturers.



More details will be available from:
Advani-Oerlikon Ltd.,
Post Box no. 1546,
Bombay—400 001.

CABLE STRAPS

Novoflex strapping system offers an effective cable binding method with perforated strapping and small studs. Made from a specially formulated PVC for prolonging the elastic properties and continuous firmness of the strapping, the system offers the facility of opening and closing of cable looms for modifications in all original wire binding purpose. Standard colour of the strapping is black but different colours are made available for bulk orders. The strapping is supplied in 100 metre and 10 metre rolls and the studs in 1,000s.

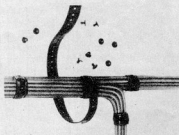

More details can be had from:
Novoflex Cable Industries,
Installation material division, P. Box.
9159, Calcutta—700 016.

IS RED AND BLUE

P C B

**SEPERATION
YOUR PROBLEM ?**

Here is a studio equipped with
computerised Graphic art equipment.

Approved by Renowned companies
like Larsen & Toubro, SUM Electronics,
Tata Burroughs, etc.



MOJ TYPE FOUNDRY

Unit No. 5, 7, & 8, Municipal Ind. Estate,
Above Market, Vile Parle (W),
Bombay 400 056.
Tel: 612 34 79.

Creator MT-84

**AVAILABLE EX-STOCK—
LOW PRICES**

- MICROPROCESSOR IC'S
- CMOS/TTL/LS IC'S
- LINEAR IC'S
- TANTALUM CAPACITORS
- CRYSTALS/TRIMPOTS
- IC SOCKETS/ZIF IC SOCKETS
- FLAT CABLES/CONNECTORS
- RECTIFIER DIODES
- SWITCHING DIODES
- ZENER DIODES
- TBA 810/1044/7204
- MAGNETIC HEADS
- TRANSISTORS/SCR
- TRIACS

GENERAL

GENERAL SALES AGENCY,

No. 4, YAMUNA BUILDING,
TARA TEMPLE LANE, OFF. LAMINGTON ROAD,
BOMBAY-400007. TEL: 369250/386178

now you can buy

BIG packs at mini rates

yes **IC** IZUMIYA IC INC (JAPAN)

High Precision Products
Are Now Available
At Very Economical Prices.

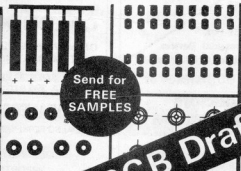
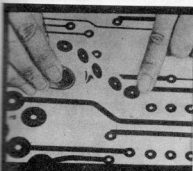

Send for
**FREE
SAMPLES**

PCB Drafting Aids

Indenting Agents
elektor ELECTRONICS pvt ltd.
3, chunam lane dr bhadkamkar marg,
bombay-400 007. ph : 367459; 369478.

SUMICO®

VERSATILE 4 in 1 AC ADAPTER FOUR OUTPUTS IN ONE™



THE ONLY REGULATED POWER AC ADAPTER OF ITS KIND.

- Convertible for 2 or 3 Pin Mains Socket.
- Selectable D.C. Outputs 1.5, 3, 4.5, & 6V Polarity Reversible.
- Regulated upto 300 mA
- Short Circuit protected with Indicator.
- Spare cords with single, universal plug are available

REMOTE AREA OR LOW POWER TV TRANSMISSION VIEWERS

YOU CAN EXTEND
THE RANGE OF ANY
TV TRANSMITTER
i.e. LOCAL/FOREIGN

By installing specially designed and matched high gain SUMICO Booster and Antenna, accurately tuned to your required channels. Outdoor/Indoor Multichannel models also available.

Contact for dealership giving full particulars of experience in the line.

USING MODERN TECHNOLOGY

SUMICO NOW THE ULTIMATE IN TV BOOSTERS



Manufacturers **IDEAL RADIONICS** P. O. Box 4100, Bombay-400 007.



WE HAVE MOVED TO

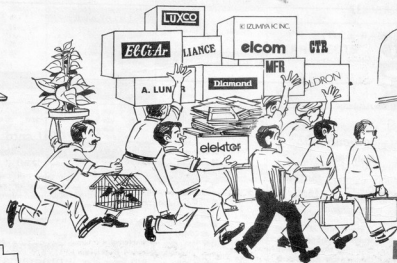

TO SERVE YOU BETTER

precious® ELECTRONICS CORPORATION
elektor ELECTRONICS pvt Ltd.

CHHOTANI BUILDING,
52 C, PROCTOR ROAD,
GRANT ROAD STATION,
BOMBAY-400 007.
PHONES: 367459, 369478

COSMIC

super hi-fi stereo speaker systems
for balanced sound and true reproduction

from 30 watts to 600 watts total power output.



COVOX 1500

Components: 2 full range woofers, 16 cms., 1 tweeter.
*40-18,000 Hz.
**30-40 Watts.



COVOX 2500

Components: Enclosure-infinite baffle, sealed, 1 acoustic-suspension woofer 16 cms., 1 acoustic-suspension midrange, 1 cone-type tweeter, with divided network.
*30-18,000 Hz.
**40-60 Watts.



COVOX 3500

Components: Enclosure-infinite baffle, sealed, 1 acoustic - suspension woofer 20.32 cms., 1 acoustic-suspension mid-range, 1 tweeter, with divided network.
*30-18,000 Hz.
**60-100 Watts.



MODEL JBL

Components: 1 full range woofer and mid-range combined, 20.5 cms., 1 tweeter, with divided network.
*30-20,000 Hz.
**60-200 Watts.

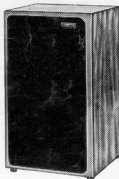

COVOX 4500

Components: Enclosure-infinite baffle, sealed, 1 acoustic - suspension woofer 25 cms., 1 acoustic-suspension mid-range 16 cms., 1 tweeter, with divided network.
*30-20,000 Hz.
**60-200 Watts.

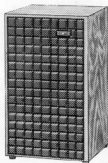

COVOX 5000

Components: Enclosure-infinite baffle, sealed, 1 full range woofer and mid-range combined 25.4 cms., 1 tweeter, with divided network.
*30-20,000 Hz.
**100-200 Watts.

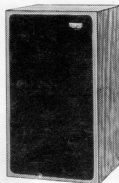

COVOX 6000

Components: Enclosure-infinite baffle, sealed, 1 acoustic-suspension woofer 30.5 cms., 2 mid-range, 1 tweeter, with divided network.
*20-20,000 Hz.
**200-300 Watts.

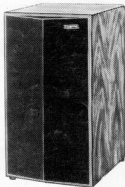

COVOX 7000

Components: 1 full range woofer and 1 mid-range combined 30 cms., 1 dome tweeter.
*20-20,000 Hz.
**200-600 Watts.

*Frequency Response Range ** Matching Amplifier Nominal Impedance 8 ohms.

International quality created for India by **COSMIC**